



**8-port USB DVI KVM Switch
CS1768 / CS1788**

User Manual



EMC Information

FEDERAL COMMUNICATIONS COMMISSION INTERFERENCE STATEMENT:

This equipment has been tested and found to comply with the limits for a Class A digital device, pursuant to Part 15 of the FCC Rules. These limits are designed to provide reasonable protection against harmful interference when the equipment is operated in a commercial environment. This equipment generates, uses, and can radiate radio frequency energy and, if not installed and used in accordance with the instruction manual, may cause harmful interference to radio communications. Operation of this equipment in a residential area is likely to cause harmful interference in which case the user will be required to correct the interference at his own expense.

The device complies with Part 15 of the FCC Rules. Operation is subject to the following two conditions: (1) this device may not cause harmful interference, and (2) this device must accept any interference received, including interference that may cause undesired operation.

FCC Caution: Any changes or modifications not expressly approved by the party responsible for compliance could void the user's authority to operate this equipment.

CE Warning: This is a class A product. In a domestic environment this product may cause radio interference in which case the user may be required to take adequate measures.

RoHS

This product is RoHS compliant.

SJ/T 11364-2006

The following contains information that relates to China.

部件名称	有毒有害物质或元素					
	铅	汞	镉	六价铬	多溴联苯	多溴二苯醚
电器部件	●	○	○	○	○	○
机构部件	○	○	○	○	○	○

- : 表示该有毒有害物质在该部件所有均质材料中的含量均在SJ/T 11363-2006规定的限量要求之下。
- : 表示符合欧盟的豁免条款, 但该有毒有害物质至少在该部件的某一均质材料中的含量超出SJ/T 11363-2006的限量要求。
- ×: 表示该有毒有害物质至少在该部件的某一均质材料中的含量超出SJ/T 11363-2006的限量要求。



User Information

Online Registration

Be sure to register your product at our online support center:

International	http://eservice.aten.com
---------------	---

Telephone Support

For telephone support, call this number:

International	886-2-8692-6959
China	86-10-5255-0110
Japan	81-3-5615-5811
Korea	82-2-467-6789
North America	1-888-999-ATEN ext 4988
United Kingdom	44-8-4481-58923

User Notice

All information, documentation, and specifications contained in this manual are subject to change without prior notification by the manufacturer. The manufacturer makes no representations or warranties, either expressed or implied, with respect to the contents hereof and specifically disclaims any warranties as to merchantability or fitness for any particular purpose. Any of the manufacturer's software described in this manual is sold or licensed *as is*. Should the programs prove defective following their purchase, the buyer (and not the manufacturer, its distributor, or its dealer), assumes the entire cost of all necessary servicing, repair and any incidental or consequential damages resulting from any defect in the software.

The manufacturer of this system is not responsible for any radio and/or TV interference caused by unauthorized modifications to this device. It is the responsibility of the user to correct such interference.

The manufacturer is not responsible for any damage incurred in the operation of this system if the correct operational voltage setting was not selected prior to operation. **PLEASE VERIFY THAT THE VOLTAGE SETTING IS CORRECT BEFORE USE.**

Package Contents

- ◆ 1 CS1768 / CS1788 8-port USB DVI KVM Switch with Rack Mounting Kit
- ◆ 2 Custom USB DVI-D KVM Cable Sets
- ◆ 1 Firmware Upgrade Cable
- ◆ 1 Power Adapter
- ◆ 1 Foot Pad Set (4 pcs)
- ◆ 1 User Instructions*

Check to make sure that all the components are present and that nothing got damaged in shipping. If you encounter a problem, contact your dealer.

Read this manual thoroughly and follow the installation and operation procedures carefully to prevent any damage to the unit, and/or any of the devices connected to it.

* Features may have been added to the CS1768 / CS1788 since this manual was published. Please visit our website to download the most up-to-date version.

© Copyright 2014 ATEN® International Co., Ltd.

Manual Date: 2014-09-18

ATEN and the ATEN logo are registered trademarks of ATEN International Co., Ltd. All rights reserved.
All other brand names and trademarks are the registered property of their respective owners.

Contents

EMC Information	ii
RoHS	ii
SJ/T 11364-2006	ii
User Information	iii
Online Registration	iii
Telephone Support	iii
User Notice	iii
Package Contents	iv
Contents	v
About this Manual	viii
Conventions	ix
Product Information	ix
1. Introduction	
Overview	1
Features	2
Requirements	4
Console	4
Computers	4
Cables	5
Operating Systems	6
Components	7
Front View	7
Rear View	9
2. Hardware Setup	
Overview	11
Installation Types	11
Before You Begin	11
Stacking and Rack Mounting	12
Stacking	12
Rack Mounting – Front	13
Rack Mounting – Rear	15
Single Stage Installation	17
Console Monitor Connection Options	18
Single Stage Installation Diagram	19
Two Stage Cascade	20
Three Stage Cascade	22
Multi-view Installation	24
Cable Connections for Multi-view Installation	24
Multi-view Installation Diagram	25
Grouping Ports into “Vertical” Channels	26
Channels Diagram	27

3. Basic Operation

Hot Plugging	29
Hot Plugging KVM Ports	29
Hot Plugging Console Ports	29
Port Selection	30
Manual Port Switching	30
Port ID Numbering	30
Powering Off and Restarting	31

4. OSD Operation

OSD Overview	33
OSD Login	33
OSD Hotkey	33
OSD Main Screen	34
OSD Main Screen Headings	34
OSD Navigation	35
OSD Functions	35
F1: GOTO	36
F2: LIST	36
F3: SET	37
F4: ADM	39
F5: SKP	43
F6: BRC	43
F7: SCAN	44
F8: LOUT	45

5. Hotkey Operation

Hotkey Port Control	47
Invoke Hotkey Mode	47
Select the Active Port	48
Auto Scan Mode	49
Invoking Auto Scan:	49
Skip Mode	50
Keyboard / Mouse Reset	51
Hotkey Beeper Control	51
Quick Hotkey Control	52
OSD Hotkey Control	52
Port OS Control	53
Restore Default Values	53
USB Reset	53
Hotkey Buzzer Control	54
Restore Default Settings	54
Video DynaSync	54
Mouse Emulation Control	54
HSM Summary Table	55

6. Keyboard Emulation

Mac Keyboard	57
Sun Keyboard	58

7. The Firmware Management Utility

Introduction	59
Downloading the Firmware Upgrade Package	59
Preparation	60
Starting the Upgrade	61
Upgrade Succeeded	63
Upgrade Failed	63
Firmware Upgrade Recovery	64
OSD Configuration Backup/Restore	65
Backup	65
Restore	66
Safety Instructions	67
General	67
Rack Mounting	69
Technical Support	70
International	70
North America	70
CS1768 / CS1788 Connection Tables	71
Specifications	72
Administrator Login Failure	73
Factory Default Hotkeys and Settings	74
Limited Warranty	74

About this Manual

This User Manual is provided to help you get the most from your CS1768 / CS1788 system. It covers all aspects of installation, configuration and operation. An overview of the information found in the manual is provided below.

Introduction, introduces you to the CS1768 / CS1788 system. Its purpose, features and benefits are presented, and its front and back panel components are described.

Hardware Setup, describes how to set up your installation. The necessary steps for a basic single stage hookup, three-stage cascade, and multi-view installation are provided.

Basic Operation, explains the fundamental concepts involved in operating the CS1768 / CS1788.

OSD Operation, provides a complete description of the CS1768 / CS1788's OSD (On Screen Display), and how to work with it.

Hotkey Operation, details all of the concepts and procedures involved in the Hotkey operation of your CS1768 / CS1788 installation.

Keyboard Operation, provides tables that list the PC to Mac and PC to Sun keyboard emulation mappings.

The Firmware Upgrade Utility, explains how to use this utility to upgrade the CS1768 / CS1788's firmware with the latest available versions and perform an OSD configuration backup/restore.

An Appendix, provides specifications and other technical information regarding the CS1768 / CS1788.

Conventions

This manual uses the following conventions:

- | | |
|---|--|
| Monospaced | Indicates text that you should key in. |
| [] | Indicates keys you should press. For example, [Enter] means to press the Enter key. If keys need to be chorded, they appear together in the same bracket with a plus sign between them: [Ctrl+Alt]. |
| 1. | Numbered lists represent procedures with sequential steps. |
| ◆ | Bullet lists provide information, but do not involve sequential steps. |
| → | Indicates selecting the option (on a menu or dialog box, for example), that comes next. For example, Start → Run means to open the <i>Start</i> menu, and then select <i>Run</i> . |
|  | Indicates critical information. |

Product Information

For information about all ATEN products and how they can help you connect without limits, visit ATEN on the Web or contact an ATEN Authorized Reseller. Visit ATEN on the Web for a list of locations and telephone numbers:

International	http://www.aten.com
North America	http://www.aten-usa.com

This Page Intentionally Left Blank

Chapter 1

Introduction

Overview

The CS1768 / CS1788 is a control unit that allows access and control of up to 8 computers from a single USB keyboard, USB mouse, and monitor (DVI or VGA) console. The CS1768 supports Single Link DVI; the CS1788 supports Dual Link DVI. The CS1768 / CS1788 can be cascaded to three levels – allowing up to 73 units to control up to 512 computers – all from the original single console. In addition the CS1768 / CS1788 features multi-view functionality, which enables the use of standard USB cables to stack up to four switches for dual, triple and quad-viewing in multiple-monitor installations where each computer is fitted with multiple video cards. Furthermore, the CS1768 / CS1788 comes with ATEN's Video DynaSync™ technology, which optimizes display resolution.

There are three convenient methods to access any computer connected to the installation: (1) using the pushbutton port selection switches located on each unit's front panel; (2) entering *Hotkey* combinations from the keyboard; and (3) selecting from menus provided by the on-screen display (OSD).

The CS1768 / CS1788 provides multimedia keyboard support and is audio enabled. Two microphones can provide audio input to each of the computers, and you can listen to the audio output of each computer on two sets of speakers (on a one-at-a-time basis). Setup is fast and easy; simply plug cables into their appropriate ports. There is no software to configure, no installation routines, and no incompatibility problems. Since the CS1768 / CS1788 intercepts keyboard input directly, it works on multiple operating platforms (PC compatible, Mac, Sun, etc.).

Since a single console manages all of the computers on your installation, a CS1768 / CS1788 KVM switch setup: (1) eliminates the expense of having to purchase a separate keyboard, monitor, and mouse for each computer; (2) saves all the space those extra components would take up; (3) saves on energy costs; and (4) eliminates the inconvenience and wasted effort involved in constantly moving from one computer to another.

Note: The CS1768 / CS1788 offers two types of installation – 1) standalone/cascade; and 2) multi-view – that require different cabling setups. Therefore, the functions of both types are not available in one installation.

Features

- ◆ One USB console controls eight Single Link DVI (CS1768) / Dual Link DVI (CS1788) or VGA computers and two additional USB 2.0 devices
- ◆ Supports both digital (DVI) and analog (VGA) video – mixed operation possible
- ◆ Cascadable to three levels – control up to 512 computers
- ◆ Multi-view feature – stack up to four CS1768 / CS1788 units and display video from up to four monitors (dual view / triple view / quad view)
- ◆ 2-port USB 2.0 hub built in*
- ◆ Fully compliant with the USB 2.0 specification
- ◆ Computer selection via front panel pushbuttons, hotkeys, and multilingual on-screen display (OSD)
- ◆ Independent switching of KVM and USB focus
- ◆ Broadcast mode – allows you to send commands from the console to all computers to perform operations simultaneously.
- ◆ OSD Backup/Restore feature – enables the administrator to back up the switch's configuration and user profile information
- ◆ Firmware upgradable
- ◆ DVI digital and analog monitor support – fully compliant with the DVI specifications
- ◆ Video DynaSync™ – exclusive ATEN technology eliminates boot-up display problems and optimizes resolution when switching between ports
- ◆ Superior video quality – 1920 x 1200 (Single Link DVI – CS1768) / 2560 x 1600 (Dual Link DVI – CS1788); 2048 x 1536 (VGA); DDC2B
- ◆ Supports widescreen resolutions
- ◆ Audio enabled – full bass response provides a rich experience for 2.1 channel surround sound systems
- ◆ Console audio ports on front panel for easy access
- ◆ Auto Scan Mode for monitoring all computers
- ◆ HDCP compatible
- ◆ Multiplatform support – Windows, Linux, Mac**, Sun**

- ◆ Console mouse port emulation/bypass feature supports most mouse drivers and multifunction mice
- ◆ Complete keyboard emulation for error-free booting
- ◆ Mac/Sun keyboard support and emulation***
- ◆ Multilingual OSD supports English, German, Japanese, Traditional Chinese, Simplified Chinese, Spanish, Russian, and French
- ◆ Multilingual keyboard mapping – supports English (US), English (UK), French, German, Japanese, Korean, Traditional Chinese, and Spanish

-
- Note:**
1. The USB 2.0 hub cannot be accessed through the switch by computers on the second or third level of a cascaded installation.
 2. For PC compatible computers. Mac and Sun computers must use the USB cable connections (see *Cables*, page 5).
 3. PC keyboard combinations emulate Mac/Sun keyboards; Mac/Sun keyboard work only with their own computers
-

Requirements

Console

- ◆ A DVI compatible monitor capable of the highest possible resolution that you will be using on any computer in the installation

Note: For multi-view installations, multiple monitors are required. See *Multi-view Installation*, page 24, for details.

- ◆ A VGA, SVGA, XGA, SXGA or multisync monitor capable of the highest resolution that you will be using on any computer in the installation (optional)
- ◆ A USB mouse
- ◆ A USB keyboard
- ◆ Microphone and speakers (optional)

Computers

The following equipment must be available on each computer:

- ◆ A DVI card

Note: 1. The quality of the display is affected by the quality of the DVI display card. For best results, we recommend you purchase a high quality product.

2. For multi-view installations, the computers require multiple DVI cards. See *Multi-view Installation*, page 24, for details.

- ◆ A VGA, SVGA, XGA, SXGA or multisync card (optional)
- ◆ Type A USB port
- ◆ Microphone and speaker ports (optional)

Note: The VGA monitor and VGA card are supported by the CS1768 / CS1788, but are both optional. Refer to *Console Monitor Connection Options*, page 18 for more information on console and computer equipment installation.

Cables

- ◆ Only custom USB DVI KVM cable sets, which are specifically designed to work with this switch, may be used to link to the computers. Two cable sets are provided with this package.

Note: The quality of the display is affected by the quality and length of the cables. If you need additional cable sets, please contact your dealer to purchase the appropriate ones for your switch.

Type	Length	Part Number
USB DVI-D Single Link	1.8 m	2L-7D02U
	3.0 m	2L-7D03U
	5.0 m	2L-7D05U
USB DVI-I Single Link	1.8 m	2L-7D02UI
	3.0 m	2L-7D03UI
USB DVI-D Dual Link	1.8 m	2L-7D02UD
	3.0 m	2L-7D03UD
	5.0 m	2L-7D05UD

- ◆ USB DVI-I Single Link for CS1768 / USB DVI-D Dual Link for CS1788
- ◆ For multi-view installations, standard USB Type A to USB Type B cables and standard DVI cables are also required.

Operating Systems

OS		Version
Windows		2000 / XP / 2003 / 2008 / Vista / 7
Linux	RedHat	9.0 and higher
	SuSE	10 / 11.1 and higher
	Debian	3.1 / 4.0
	Ubuntu	7.04 / 7.10
UNIX	AIX	4.3 and higher
	FreeBSD	5.5 and higher
	Sun	Solaris 8 and higher
Novell	Netware	6.0 and higher
Mac	OS 9 to 10.6 (Snow Leopard)	

Note: 1. Supports Linux Kernel 2.6 and higher.

2. The CS1768 / CS1788 has a built-in USB 2.0 hub, and does not support PCs or operating systems that do not support USB 2.0.
-

Components

Front View

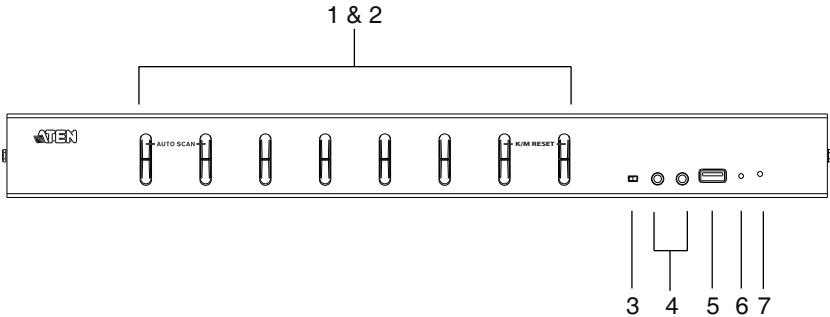

No.	Component	Description
1	Port Selection Pushbuttons	<p>For manual port selection (see <i>Port Selection</i>, page 30, also):</p> <ul style="list-style-type: none"> ◆ Press a port selection pushbutton for longer than two seconds to bring the KVM, USB hub, and audio focus to the computer attached to its corresponding port. ◆ Press a pushbutton for less than two seconds to bring the KVM and audio focus to the computer attached to its corresponding port. ◆ Press push buttons 1 and 2 simultaneously for 2 seconds to start Auto Scan Mode. See <i>Auto Scan Mode</i>, page 49, for details. ◆ Press push buttons 7 and 8 simultaneously for 2 seconds to perform a keyboard and mouse reset. See <i>Keyboard / Mouse Reset</i>, page 51, also
2	Port LEDs	<p>The Port LEDs are built into the Port Selection Switches. The upper ones are the KVM Port LEDs; the lower ones are the USB LEDs:</p> <p>KVM</p> <ul style="list-style-type: none"> ◆ Lights DIM ORANGE to indicate that the computer attached to the corresponding port is up and running (On Line). ◆ Flashes to indicate that Firmware Upgrade mode is in effect. ◆ Changes to BRIGHT ORANGE to indicate that the computer attached to its corresponding port is the one that has the KVM focus (Selected). ◆ Flashes to indicate that the computer attached to its corresponding port is being accessed under Auto Scan mode. <p>USB</p> <ul style="list-style-type: none"> ◆ Lights GREEN to indicate that the computer attached to its corresponding port is the one that has access to the USB peripherals. <p>Note: The USB 2.0 hub cannot be accessed through the switch by computers on the second or third level of a cascaded installation.</p>

No.	Component	Description
3	Firmware Upgrade Recovery Switch	During normal operation and while performing a firmware upgrade, this switch should be in the NORMAL position. If a firmware upgrade operation does not complete successfully, this switch is used to perform a firmware upgrade recovery. See <i>Firmware Upgrade Recovery</i> , page 64, for details.
4	Audio Ports	The cables from your main speakers and main microphone plug in here. The speakers and microphone plugged in here have priority over those in the rear panel.
5	USB 2.0 Hub	USB 2.0 peripherals (printers, scanners, etc.) can plug into this port (this may require an extra power adapter). Note: The USB 2.0 hub cannot be accessed through the switch by computers on the second or third level of a cascaded installation.
6	Reset Switch	Pressing this switch performs a system reset. When the system is reset, the switch beeps, and the port LEDs flash in succession until the reset is complete. After the reset is complete you can login again. Note: This switch is recessed and must be pushed with a small object, such as the end of a paper clip or a ballpoint pen.
7	Power LED	Lights to indicate that the switch is powered up and ready to operate.

Rear View

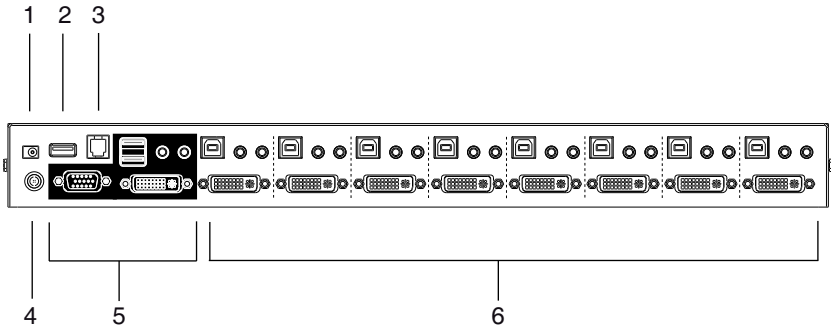

No.	Component	Description
1	Power Jack	The power adapter cable plugs in here.
2	USB 2.0 Hub	USB 2.0 peripherals (printers, scanners, etc.) can plug into this port (this may require an extra power adapter). Note: The USB 2.0 hub cannot be accessed through the switch by computers on the second or third level of a cascaded installation.
3	Firmware Upgrade Port	The firmware upgrade cable that transfers the firmware upgrade data from the administrator's computer to the CS1768 / CS1788 plugs into this RJ-11 connector.
4	Grounding Terminal	The grounding wire used to ground the CS1768 / CS1788 attaches here.
5	Console Port Section	The cables from your console DVI and/or VGA monitor, USB keyboard, USB mouse, speakers, and microphone plug in here. Each connector is marked with an appropriate icon to indicate itself.
6	KVM Port Sections	The cables that link the switch to your computers plug in here. Each KVM port section is comprised of a microphone jack, speaker jack(s), USB type B socket and a DVI-I connector.

This Page Intentionally Left Blank

Chapter 2

Hardware Setup

Overview

For convenience and flexibility that allows mixing multiple platforms, the CS1768 / CS1788 design utilizes custom USB DVI KVM cables that serve as intermediaries between the switch and the connected computers (refer to the installation diagram on page 17).

A separate custom USB DVI KVM cable is required for each computer connection. The custom KVM cables are listed under *Cables*, on page 5. Consult your dealer to find out which custom KVM cables best fit your needs.

Installation Types

The CS1768 / CS1788 offers two types of installation – 1) standalone/cascade; and 2) multi-view – that require different cabling setups. Therefore, the functions of both types are not available in one installation. See the following sections in this chapter for details about the different cabling requirements.

Before You Begin



1. Important safety information regarding the placement of this device is provided on page 67. Please review it before proceeding.
2. Make sure that power to all devices that you will be installing has been turned off. You must unplug the power cords of any computers that have the Keyboard Power On function.

Stacking and Rack Mounting

The CS1768 / CS1788 can be stacked on the desktop or rack mounted at the front or rear of the rack. The following sections take you through the procedures for each method.

-
- Note:** 1. Allow at least 5.1 cm on each side for adequate ventilation and 12.7 cm at the rear for power cord and cable clearance.
2. The standard rack mounting kit does not include screws or cage nuts. If you need additional screws or cage nuts, contact your rack dealer.
-

Stacking

The CS1768 / CS1788 can be placed on any level surface that can safely support its weight and the weight of the attached cables. Make sure that the surface is clean and free of any materials that can block the exhaust vents or otherwise interfere with normal operation of the switch.

To place the CS1768 / CS1788, or to stack units if you are cascading them, remove the backing material from the bottom of the rubber feet that came with this package, and stick them onto the bottom panel at the corners, as shown in the diagram, below:

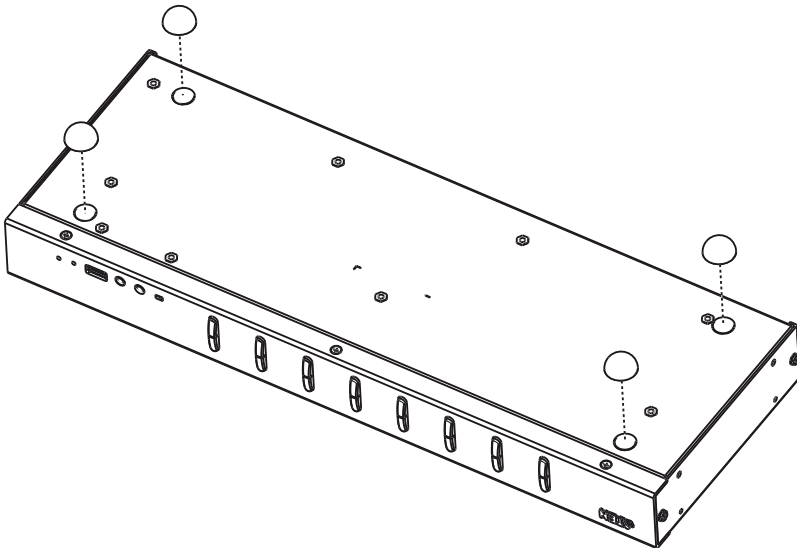

Rack Mounting – Front

1. Remove the screws from the left and right sides of the switch (2 screws total) near the front of the switch.

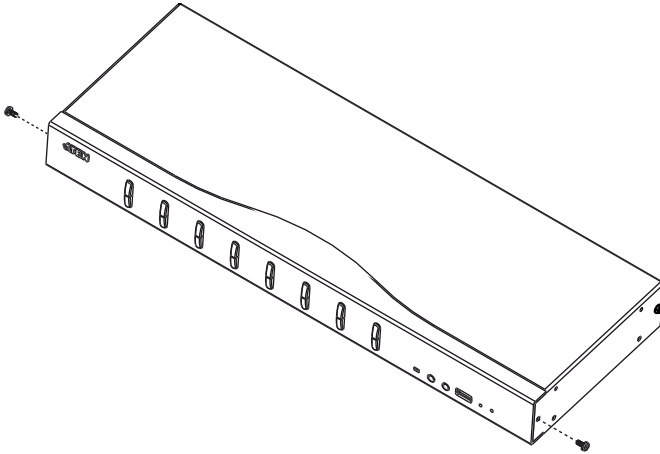

2. Use the M3 x 8 Phillips hex head screws supplied with the rack mounting kit to screw the rack mounting brackets into the sides near the front of the unit.

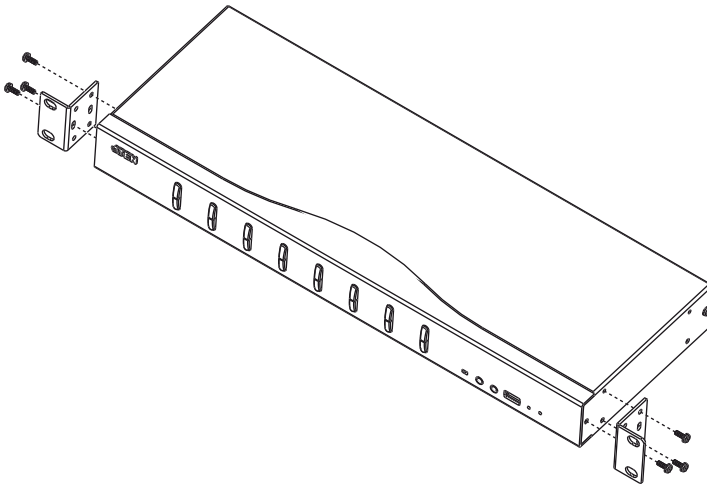

(Continues on next page.)

(Continued from previous page.)

3. Place the KVM switch in the rack. Position it so that the holes in the mounting brackets line up with the holes in the rack. Secure the mounting brackets to the front of the rack.

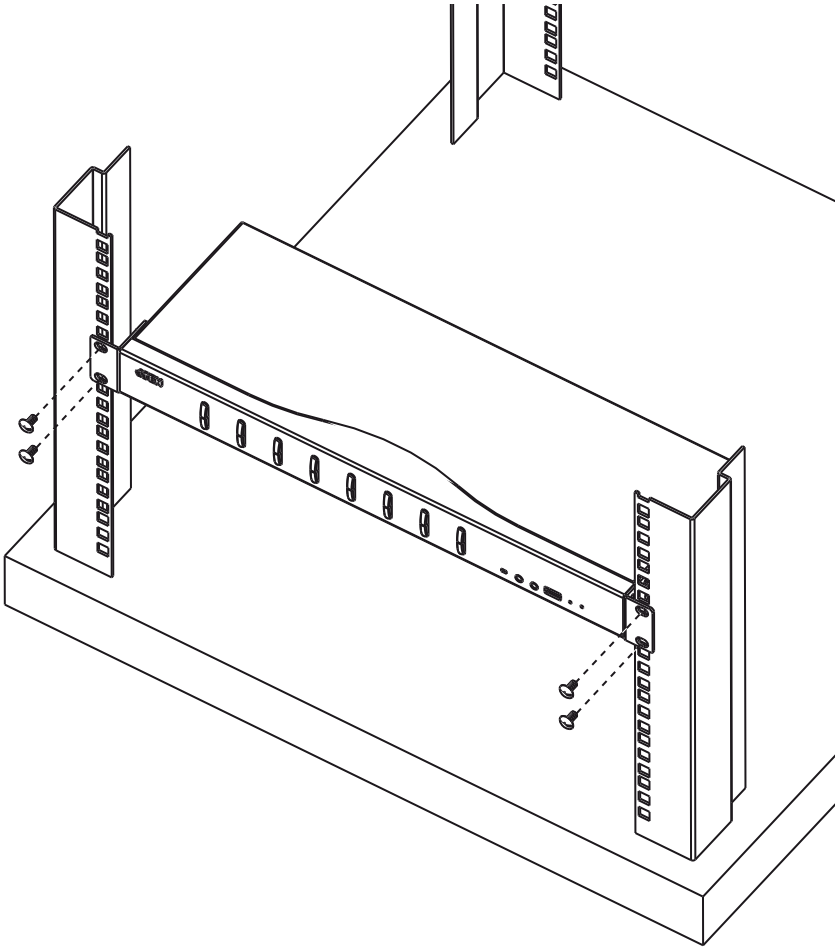

Rack Mounting – Rear

1. Remove 1 screw each from the left and right sides of the switch (2 screws total) near the rear of the unit.

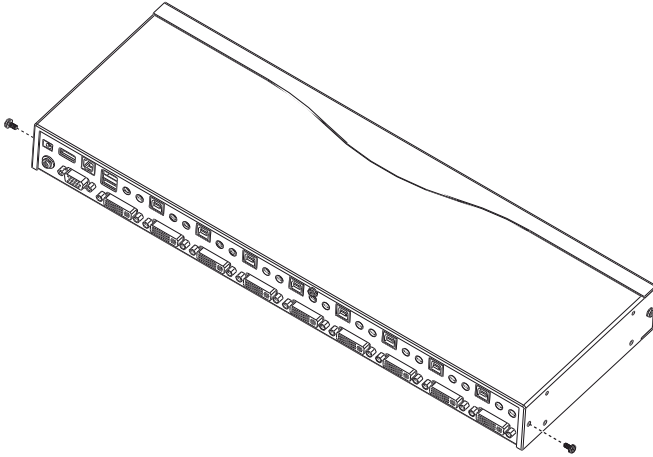

2. Use the M3 x 8 Phillips hex head screws supplied with the rack mounting kit to screw the rack mounting brackets into the sides near the rear of the unit.

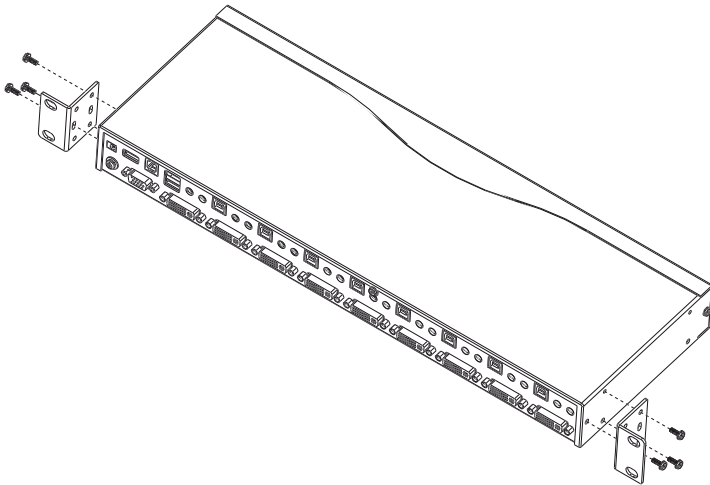

(Continues on next page.)

(Continued from previous page.)

3. Place the KVM switch in the rack. Position it so that the holes in the mounting brackets line up with the holes in the rack. Secure the mounting brackets to the rear of the rack.

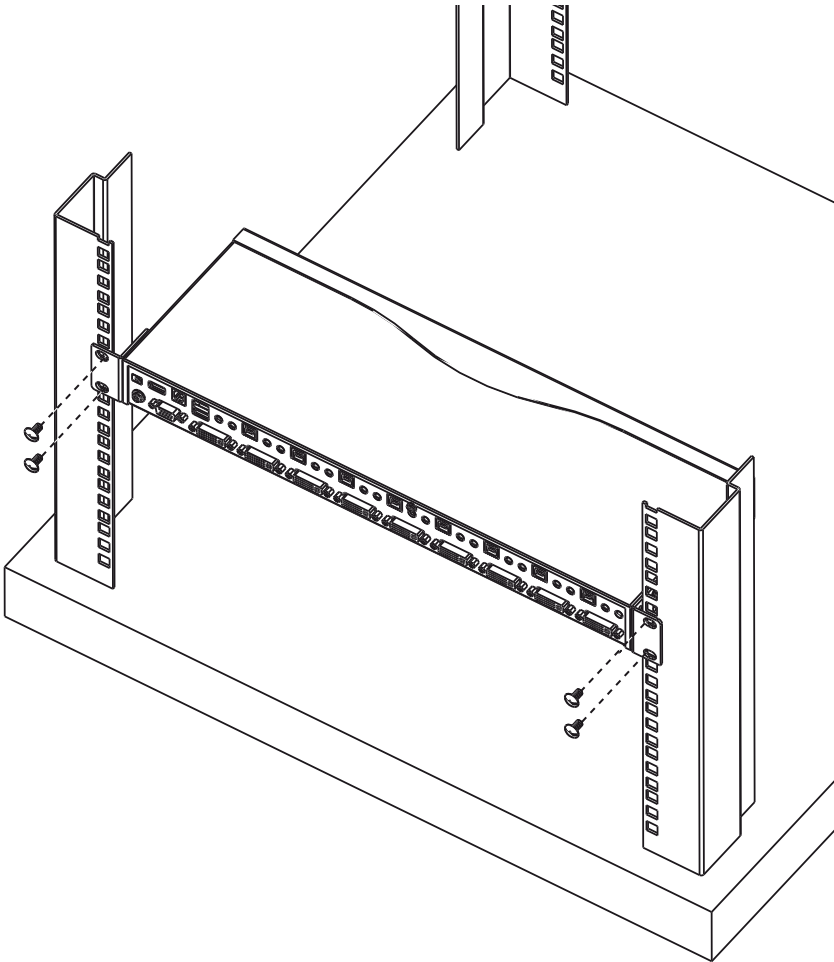

Single Stage Installation

To set up your single stage CS1768 / CS1788 installation, refer to the installation diagram on page 19 (the numbers in the diagrams correspond to the steps, below), and do the following:

1. Plug your USB keyboard and USB mouse into the USB console ports located on the unit's rear panel.
2. Depending on your console monitor's interface, connect your monitor using one of the following methods (see *Console Monitor Connection Options*, page 18), and power on:
 - a) One DVI monitor (DVI-I) – plug your DVI console monitor into the DVI console port located on the unit's rear panel;
 - b) One DVI (DVI-D + VGA) monitor – plug your dual-interface console monitor into both the DVI and VGA console ports;
 - c) Two Monitors (1 x DVI; 1 x VGA) – plug your DVI monitor into the DVI console port, and plug your VGA monitor into the VGA console port.

Note: The CS1768 / CS1788 supports DVI, VGA, and dual interface monitors, but only one video signal (DVI or VGA) can be displayed at a time – the signal will display on *either* the DVI monitor *or* the VGA monitor, depending on the OSD settings. See *SET COMPUTER VIDEO INPUT*, page 42 for details about setting the correct video input and output for your video requirements.

3. Plug your main microphone and speakers into the console microphone and speaker jacks located on the unit's front panel. The microphone and speakers plugged into this panel have priority over those in the rear panel.
4. Plug your secondary microphone and speakers into the console audio ports located on the unit's rear panel.
5. Using the custom USB DVI KVM cable set provided with this package, plug the DVI connector into any available DVI socket in the KVM port section of the switch, then plug the accompanying USB and audio connectors into their corresponding USB, microphone, and speaker sockets.

Note: Verify that all the plugs are in the same KVM Port sockets (all in Port 1, all in Port 2, etc.).

6. At the other end of the cable, plug the USB, video, microphone, and speaker cables into their respective ports on the computer.
7. Plug your USB peripherals into the type A sockets in the USB hub section.
8. Plug the power adapter that came with your switch into an AC power source, then plug power adapter cable into the switch's Power Jack.
9. Turn on the power to the computers.

Console Monitor Connection Options

2a. One DVI Monitor (DVI-I connector)

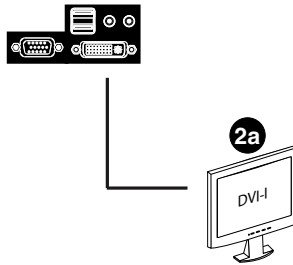

2b. One DVI Monitor (DVI-D + VGA connectors)

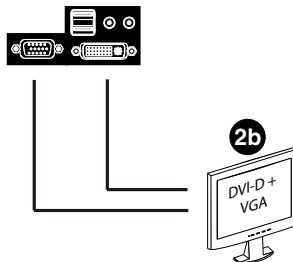

2c. Two Monitors (1 x DVI; 1 x VGA)

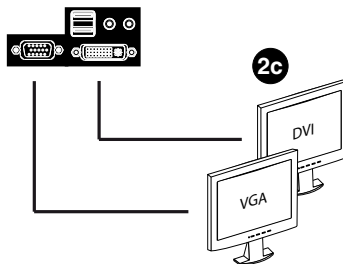

Single Stage Installation Diagram

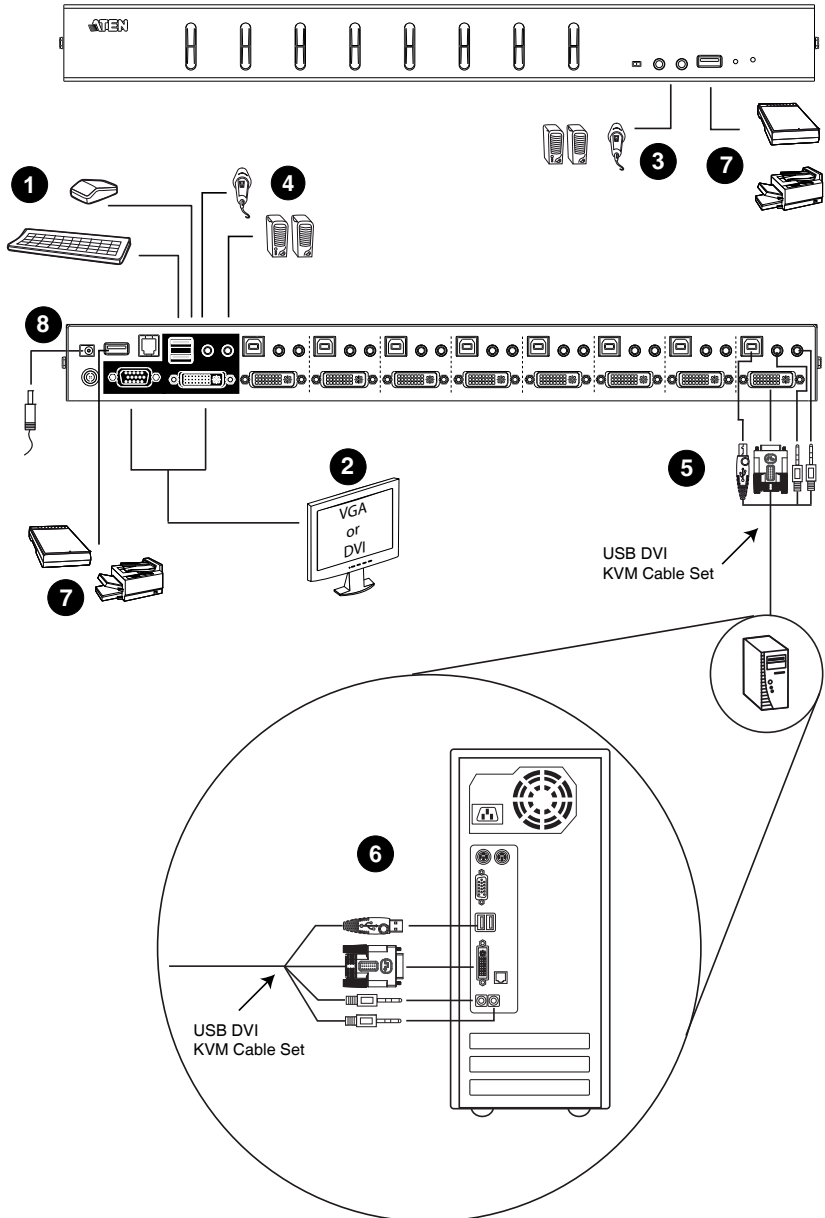

Two Stage Cascade

To control even more computers, additional CS1768 / CS1788 units can be cascaded from the KVM ports of the First Stage unit. The cascaded CS1768 / CS1788s that connect back to the First Stage unit are considered Second Stage units. As many as 64 computers can be controlled in a complete two stage installation. A table showing the relation between the number of computers and the number of units needed to control them is provided on page 71.

To set up a two stage installation, refer to the *Two Stage Installation* diagram on the next page as you do the following:

1. Make sure that power to all the devices you will be connecting up, including all preexisting devices on the installation, have been turned off.
2. Use a custom USB DVI KVM cable set (see *Cables*, page 5) to connect any available KVM Port on the First Stage unit to the Console ports of the Second Stage unit.

Note: Plug the USB Type B connector into the upper USB port in the Console section (they are both marked with a similar icon to remind you of the correct USB port).

3. Using another custom USB DVI KVM cable set (provided with this package), plug the DVI connector into any available DVI socket in the KVM port section of the switch, then plug the accompanying USB Type A, microphone and speaker connectors into their corresponding USB, microphone, and speaker sockets.

Note: Verify that all the plugs are in the same KVM Port sockets (all in Port 1, all in Port 2, etc.), and that each socket is marked with an appropriate icon to indicate itself.

4. At the other end of the cable, plug the USB Type B, video, microphone, and speaker cables into their respective ports on the computer.
5. Repeat steps 3 and 4 for any other computers you are connecting up.
6. For each Second Stage unit, plug the power adapter cable into its Power Jack, then plug the power adapter into an AC source.
7. Plug the First Stage unit's power adapter cable into its Power Jack, then plug the power adapter into an AC source.

(Continues on next page.)

8. Turn on the power to all the computers.

Note: 1. The Power On sequence requires that all Second Stage units be powered on first. After the second stage units are on, power on all the First Stage units. After the Second and First stage units have been powered on, the computers can be powered on.

2. The USB 2.0 hub cannot be accessed through the switch by computers on the second or third level of a cascaded installation.

Two Stage Installation Diagram

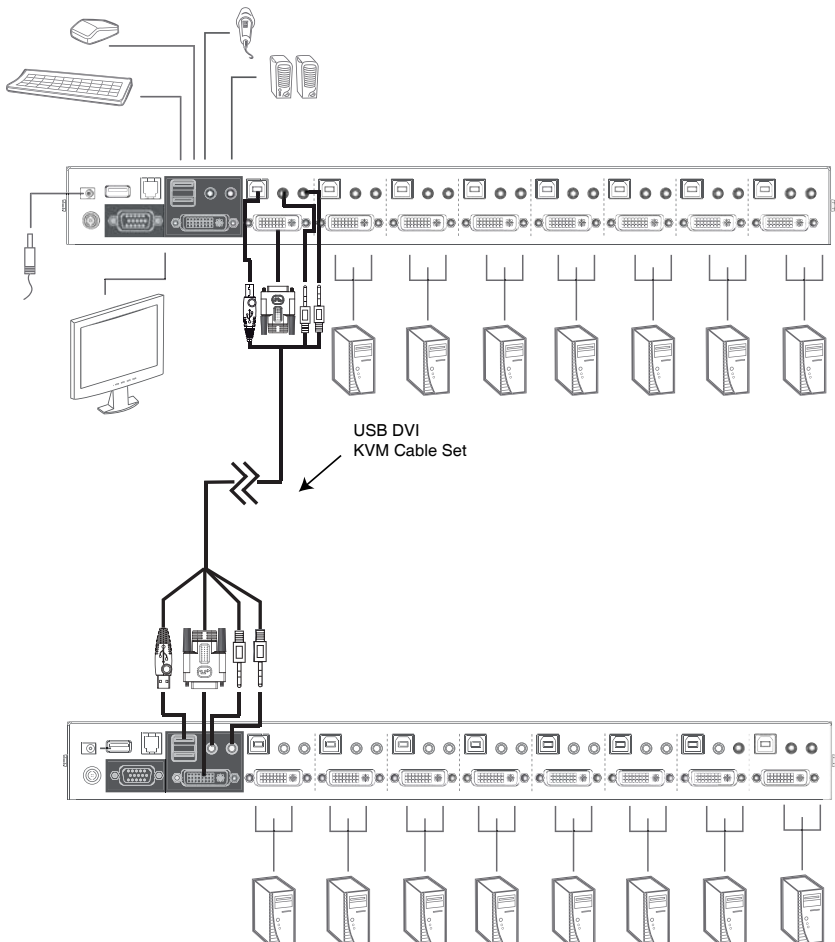

Three Stage Cascade

The procedures for setting up a three stage installation are essentially the same as for a two stage installation. With a three stage setup, as many as 512 computers can be controlled in a complete installation. A table showing the relation between the number of computers and the number of switches needed to control them is provided on page 71.

Once you have finished cabling up (see *Two Stage Cascade*, page 20 if necessary), power up according to the following sequence:

1. For each Third Stage unit, plug the power adapter cable into the switch's Power Jack; plug the power adapter into an AC source.
2. For each Second Stage unit, plug the power adapter cable into the switch's Power Jack; plug the power adapter into an AC source.
3. Plug the First Stage unit's power adapter cable into its Power Jack, then plug the power adapter into an AC source.
4. Turn on the power to all the computers.

-
- Note:**
1. The Power On sequence requires that all Second Stage units be powered on first. After the second stage units are on, power on all the First Stage units. After the Second and First stage units have been powered on, the computers can be powered on.
 2. The USB 2.0 hub cannot be accessed through the switch by computers on the second or third level of a cascaded installation.
-

Three Stage Installation Diagram

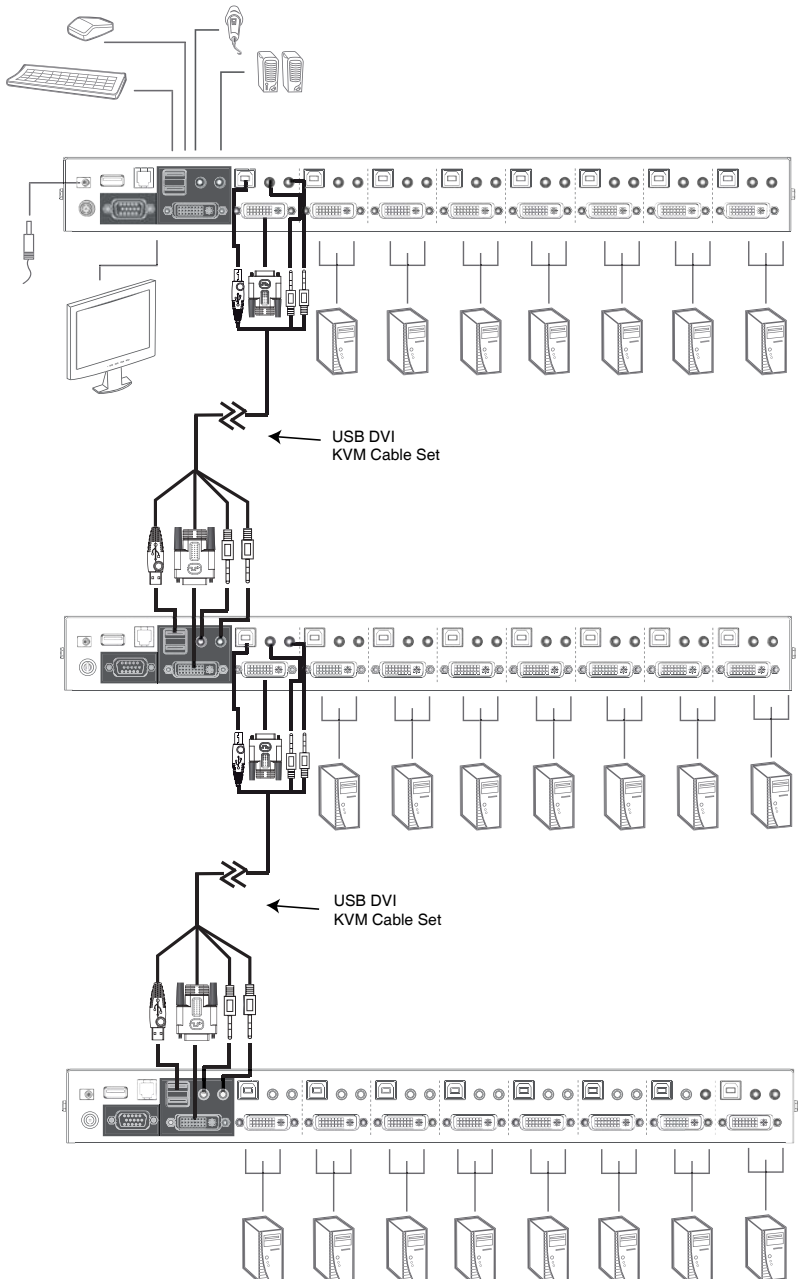

Multi-view Installation

The CS1768 / CS1788's multi-view feature allows you to stack two, three or four units in a dual/triple/quad-view installation to control up to seven computers at once. This installation requires different cabling than the standard cascade and offers an extra level of switching flexibility for multiple-monitor installations where each computer is fitted with multiple video cards.

Cable Connections for Multi-view Installation

To set up your multi-view installation, refer to the installation diagram on the next page (the numbers in the diagrams correspond to the steps, below), and do the following:

1. Use a standard USB Type A-to-USB Type B cable to connect the Port 8 USB Type A port on the first stage unit to the USB Type B port in the Console section of the second switch.

Note: Port 8 is reserved to connect the units in a multi-view installation, so up to seven computers can be attached, using KVM ports 1–7.

2. Use DVI cables to connect the DVI KVM port on the second CS1768 / CS1788 unit to the second video-in port on the computers.

Note: Only DVI video cables are necessary – the other ports in the KVM section are not required in this installation.

3. Connect a display to the console section of the second switch.
4. Repeat steps 1–3 for any additional units, up to a total of four switches.
5. Connect the cables for the first switch. See *Single Stage Installation*, page 17 for full details. All video, audio and peripheral devices must be connected to the first switch.
6. Power up the CS1768 / CS1788 units, starting with the first switch, and then power on the computers.

Multi-view Installation Diagram

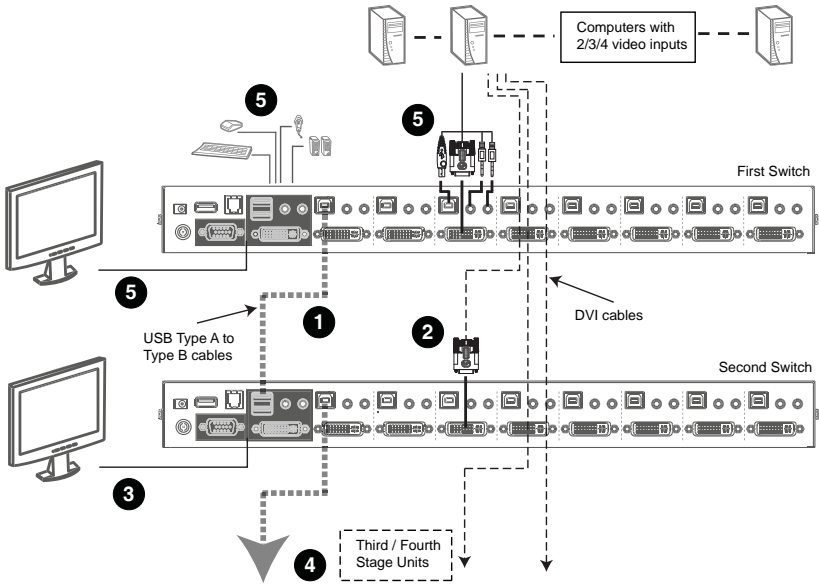

Grouping Ports into “Vertical” Channels

Once the cables have been connected and multi-view mode has been selected in the OSD, the CS1768 / CS1788 auto-detects the channels and viewing modes. Users can then assign them a channel number as the port name (the channels are represented by the vertical columns in the diagram below). So, all the Port 1s become Channel 1, all the Port 2s become Channel 2, ... , and all the Port 7s become Channel 7. The ports will all be switched at the same time, channel by channel.

Depending on the number of stages in your stack, a CS1768 / CS1788 installation offers dual view (two stages), triple view (three stages) and quad view (four stages) scenarios. For reference purposes, the example shows a four-stage installation with quad view functionality.

Note: Only one video signal (DVI or VGA) can be displayed at a time, depending on the configuration of the CS1768 / CS1788 unit on the first switch.

Channels Diagram

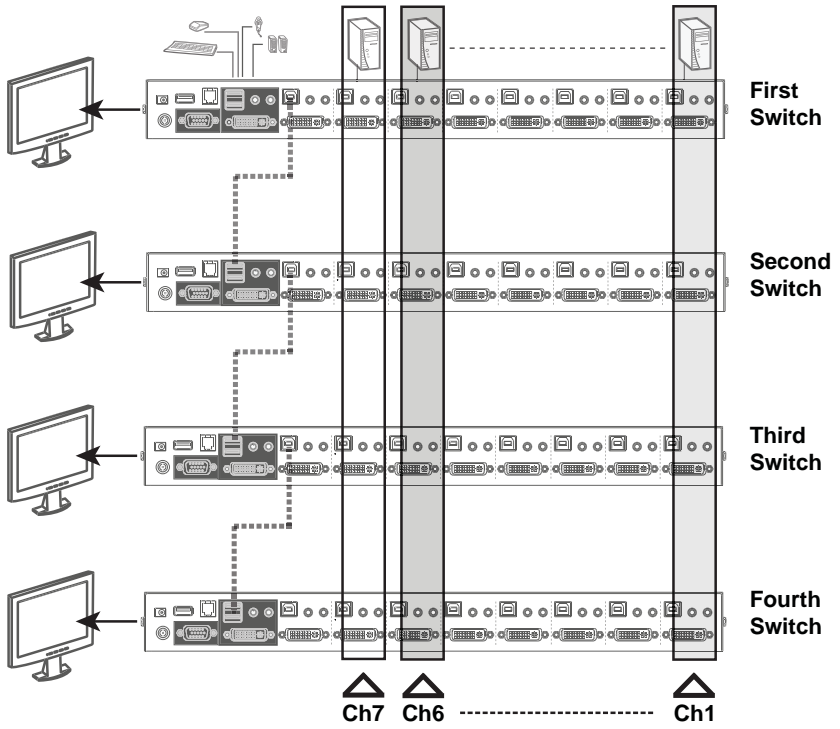

This Page Intentionally Left Blank

Chapter 3

Basic Operation

Hot Plugging

The CS1768 / CS1788 supports *hot plugging* – components can be removed and added back into the installation by unplugging their cables from the ports without the need to shut the unit down. In order for hot plugging to work properly, the procedures described below must be followed:

Hot Plugging KVM Ports

In order for the OSD menus to correspond to KVM port changes, you must manually reconfigure the OSD to reflect the new port information. See the *F3 SET* (page 37) and *F4 ADM* (page 39), functions for details.

Note: If the computer's operating system does not support hot plugging, this function may not work properly.

Hot Plugging Console Ports

The keyboard, monitor, and mouse can all be hot plugged. When hot plugging the mouse:

- ◆ You may unplug and replug the mouse (to reset the mouse, for example), as long as you use the same mouse.
- ◆ If you plug in a different mouse, all the computers on the installation must be shut down for 10 seconds, then restarted following the power up sequence described under Steps 6, 7, and 8 under *Two Stage Cascade*, page 20

Note: If, after hot plugging there is no response to keyboard and/or mouse input, perform a *Keyboard and Mouse Reset* by simultaneously pressing the 1 and 2 front panel port LEDs.

Port Selection

The CS1768 / CS1788 provides three port selection methods to access the computers on the installation: Manual, an OSD (on-screen display) menu system, and Hotkeys. See Chapter 4, *OSD Operation* and Chapter 5, *Hotkey Operation* for more information.

Manual Port Switching

Use the front panel pushbutton switches to manually switch to a port.

Port ID Numbering

Each port on a CS1768 / CS1788 installation is assigned a unique *Port ID*. You can directly access any computer on any level of the installation by specifying the Port ID that the computer is connected to – either with the OSD (see *OSD Operation*, page 33), or with the Hotkey port selection method (see *Hotkey Operation*, page 47).

- ♦ A computer attached to a master unit has a two digit Port ID (from 01–08 for the CS1768 / CS1788) that corresponds to the KVM port number that it is connected to.
- ♦ A computer attached to a slave unit has a four digit Port ID.

The first two digits represent the KVM port number on the master and the second two digits represent the KVM port number on the slave unit that the computer is connected to. For example, a Port ID of 02–08 would refer to a computer that is connected to KVM port 8 of a slave unit that links back to KVM port 2 of the master unit.

Powering Off and Restarting

If it becomes necessary to power off a CS1768 / CS1788, do the following before restarting it:

1. Unplug the CS1768 / CS1788 from its power source.
2. Shut down all the computers that are attached to it.

Note: Unplug the power cords of any computers that have the *Keyboard Power On* function. Otherwise, the CS1768 / CS1788 will still receive power from the computers.

3. Wait 10 seconds, then plug the CS1768 / CS1788 back in.
4. Power on the computers.

Note: If there are stations cascaded down from the master CS1768 / CS1788, all the cascaded stations and the computers attached to them must be shut down as well.

This Page Intentionally Left Blank

Chapter 4

OSD Operation

OSD Overview

The on-screen display (OSD) is a mouse and keyboard enabled, menu driven method to handle computer control and switching operations. All procedures start from the OSD main screen.

OSD Login

The OSD incorporates a two level (administrator / user) password system. Before the OSD main screen displays, a login screen appears requiring a password. If this is the first time that the OSD is used, or if the password function has not been set, simply press **[Enter]**. The OSD main screen displays in administrator mode. In this mode, you have administrator privileges, with access to all administrator and user functions, and can set up operations (including password authorization) as you like. If the password function has been set, you must provide an appropriate administrator/user password in order to access the OSD.

OSD Hotkey

You can display the OSD on the console monitor while also viewing the display of any port on the CS1768 / CS1788 by pressing the **[Scroll Lock]** key twice.

Note: You can optionally change the OSD hotkey to the Ctrl key, in which case you would press **[Ctrl]** twice (see *OSD Hotkey*, page 37). With this method, you must press the same **[Ctrl]** key.

OSD Main Screen

When you invoke the OSD, a screen similar to the one below appears:



- Note:**
1. The diagram depicts the administrator's main screen. The user main screen does not show the **F4** and **F6** functions, since these are reserved for the administrator and can't be accessed by users.
 2. The OSD always starts in list view, with the highlight bar at the same position it was in the last time it was closed.
 3. Only the ports that have been set accessible by the administrator for the current logged in user are visible (see *SET ACCESSIBLE PORTS*, page 39, for details).
 4. If the port list is collapsed, click on a switch number, or move the highlight bar to it then press the right arrow key to expand the list. Similarly, to collapse a switch's port list, click on the switch number, or move the highlight bar to it then press the left arrow key to collapse the list.

OSD Main Screen Headings

PN	This column lists the port ID numbers for all the KVM ports on the installation. The simplest method to access a particular computer is move the highlight bar to it, then press Enter .
QV	If a port has selected for quick view scanning (see <i>Set Quick View Ports</i> , page 41), an arrowhead displays in this column.
	The computers that are powered on and are online have a sun symbol in this column.
NAME	If a port has been given a name (see <i>Edit Port Names</i> , page 40), its name appears in this column.

OSD Navigation

- ◆ To dismiss the menu, and deactivate OSD, click the **X** at the upper right corner of the OSD window; or press **[Esc]**.
- ◆ To log out, click **F8** at the top of the main screen, or press **[F8]**.
- ◆ To move up or down through the list one line at a time, click the up and down triangle symbols (**▲▼**) or use the up and down arrow keys. If there are more list entries than what can appear on the main screen, the screen will scroll.
- ◆ To move up or down through the list one screen at a time, click the up and down arrow symbols (**↑↓**), or use the **[Pg Up]** and **[Pg Dn]** keys. If there are more list entries than what can appear on the main screen, the screen will scroll.
- ◆ To activate a port, double-click it, or move the highlight bar to it then press **[Enter]**.
- ◆ After executing any action, you automatically go back to the menu one level above.

OSD Functions

OSD functions are used to configure and control the OSD. For example, you can rapidly switch to any port, scan selected ports, limit the list you wish to view, designate a port as a quick view port, create or edit a port name, or make OSD setting adjustments.

To access an OSD function:

1. Either click a function key field at the top of the main screen, or press a function key on the keyboard.
2. In the submenus that appear make your choice either by double-clicking it, or moving the highlight bar to it, then pressing **[Enter]**.
3. Press **[Esc]** to return to the previous menu level.

F1: GOTO

Clicking the **F1** field or pressing **[F1]** activates the GOTO function. GOTO allows you to switch directly to a port either by keying in the port's *Name*, or its *Port ID*.

- ♦ To use the name method, key in **1**; key in the port's *Name*; then press **[Enter]** to switch KVM, Audio and USB focus; or **[Spacebar]** to switch KVM and Audio only.
- ♦ To use the port ID method, key in **2**; key in the *Port ID*; then press **[Enter]** to switch KVM, Audio and USB focus; or **[Spacebar]** to switch KVM and Audio only.

Note: You can key in a partial name or port ID. In that case, the screen will show all the computers that the user has *View* rights to (see *SET ACCESSIBLE PORTS*, page 39), that match the name or port ID pattern, regardless of the current list settings (see *F2 LIST*, page 36, for details).

To return to the OSD main screen without making a choice, press **[Esc]**.

F2: LIST

This function lets you broaden or narrow the scope of which ports the OSD displays on the main screen. The submenu choices and their meanings are given in the table below.

Choice	Meaning
ALL	Lists all of the ports on the installation that have been set accessible by the administrator for the current logged in user.
QUICK VIEW	Lists only the ports that have been selected as quick view ports (see <i>SET QUICK VIEW PORTS</i> , page 41).
POWERED ON	Lists only the ports that have their attached computers powered on.
QUICK VIEW + POWERED ON	Lists only the ports that have been selected as quick view ports (see <i>SET QUICK VIEW PORTS</i> , page 41), and that have their attached computers powered on.

Move the highlight bar to the choice you want, then press **[Enter]**. An icon appears before the choice to indicate that it is the currently selected one.

F3: SET

This function allows the administrator and each user to set up his own working environment. A separate profile for each is stored by the OSD and is activated according to the username that was provided during login.

To change a setting:

1. Double-click it; or move the highlight bar to it, then press **[Enter]**.
2. After you select an item, a submenu with further choices appears. To make a selection, either double-click it; or move the highlight bar to it, then press **[Enter]**. An icon appears before the selected choice to indicate which one it is. The settings are explained in the following table:

Setting	Function
OSD HOTKEY	<p>Selects which hotkey activates the OSD function:</p> <p>[Scroll Lock] [Scroll Lock] or [Ctrl] [Ctrl].</p> <p>Since the [Ctrl] key combination may conflict with programs running on the computers, the default is the [Scroll Lock] combination.</p>
PORT ID DISPLAY POSITION	<p>Allows each user to customize the position where the port ID appears on the screen. The default is the upper left corner, but users can choose to have it appear anywhere on the screen.</p> <p>Use the mouse or the arrow keys plus Pg Up, Pg Dn, Home, End, and 5 (on the numeric keypad with Num Lock off), to position the port ID display, then double-click or press [Enter] to lock the position and return to the Set submenu.</p>
PORT ID DISPLAY DURATION	<p>Determines how long a port ID displays on the monitor after a port change has taken place. The choices are: 3 Seconds and Always Off.</p>
PORT ID DISPLAY MODE	<p>Selects how the port ID is displayed: the port number plus the port name (PORT NUMBER + PORT NAME) (default); the port number alone (PORT NUMBER); or the port name alone (PORT NAME).</p>
SCAN DURATION	<p>Determines how long the focus dwells on each port as it cycles through the selected ports in Auto Scan mode (see <i>F7 SCAN</i>, page 44). Key in a value from 1–255 seconds, then press [Enter]. Default is 5 seconds; a setting of 0 disables the SCAN function.</p>

(Continues on next page.)

(Continued from previous page.)

Setting	Function
SCAN-SKIP MODE	<p>Selects which computers will be accessed under skip mode (see <i>F5 SKP</i>, page 43), and Auto Scan mode (see <i>F7 SCAN</i>, page 44). Choices are:</p> <p>ALL - All the ports which have been set accessible (see <i>SET ACCESSIBLE PORTS</i>, page 39);</p> <p>QUICK VIEW - Only those ports which have been set accessible and have been selected as quick view ports (see <i>SET QUICK VIEW PORTS</i>, page 41);</p> <p>POWERED ON - Only those ports which have been set accessible and are powered on;</p> <p>QUICK VIEW + POWERED ON - Only those ports which have been set accessible and have been selected as quick view ports and are powered on. The default is ALL.</p> <p>Note: The quick view choices only show up on the administrator's screen, since only he has <i>Quick View</i> setting rights (see <i>SET QUICK VIEW PORTS</i>, page 41, for details).</p>
SCREEN BLANKER	<p>If there is no input from the console for the amount of time set with this function, the screen is blanked. Key in a value from 1–30 minutes, then press [Enter]. The default setting of 0 disables this function.</p>
HOTKEY COMMAND MODE	<p>Enables / disables the hotkey command function in case a conflict with programs running on the computers occurs.</p>
HOTKEY	<p>Sets the keyboard shortcut for invoking <i>Hotkey Mode</i> (see page 47). Choices are: NUM LOCK + - (minus) (default), and CTRL + F12.</p>
OSD LANGUAGE	<p>Sets the language used in the OSD. Choices are: English (default), German, Japanese, Simplified Chinese and Traditional Chinese, Spanish, French, and Russian.</p>

F4: ADM

F4 is an administrator only function. It allows the administrator to configure and control the overall operation of the OSD. To change a setting double-click it, or use the up and down arrow keys to move the highlight bar to it then press **[Enter]**.

After you select an item, a submenu with further choices to select from appears. Double-click an item, or move the highlight bar to it then press **[Enter]**. An icon appears before the selected item so that you know which one it is. The settings are explained in the following table:

Setting	Function
SET USER LOGIN	<p>This function is used to set usernames and passwords for the administrator and users:</p> <ol style="list-style-type: none"> 1. Usernames and passwords for one administrator and four users can be set. 2. After you select the administrator field or one of the user fields, a screen that allows you to key in the username and password appears. Usernames and passwords can be from 1 to 16 characters long and can consist of any combination of letters and numbers (A–Z, 0–9) and some additional keys (* () + : - , ? . / space). 3. For each individual, key in the username and password, confirm the password, then press [Enter]. 4. To modify or delete a previous username and/or password, use the backspace key to erase individual letters or numbers. Press [Enter] when done. <p>Note: Usernames and passwords are not case sensitive. Usernames are displayed in capital letters in the OSD.</p>
SET ACCESSIBLE PORTS	<p>This function allows the administrator to define user access to the computers on the installation on a port-by-port basis.</p> <p>For each user, select the target port; then press the [Spacebar] to cycle through the choices: F (full access), V (view only), or blank. Repeat until all access rights have been set, then press [Enter]. The default is F for all users on all ports.</p> <p>Note:</p> <ul style="list-style-type: none"> ◆ A blank setting means that no access rights are granted. The port will not show up on the user's LIST on the main screen. ◆ The administrator always has full access to all ports.

(Continues on next page.)

(Continued from previous page.)

Setting	Function
SET LOGOUT TIMEOUT	<p>If there is no input from the console for the amount of time set with this function, the user is automatically logged out. A login is necessary before the console can be used again.</p> <p>This enables other users to gain access to the computers when the original user is no longer accessing them, but has forgotten to log out. To set the timeout value, key in a number from 1–180 minutes, then press [Enter]. The default setting of 0 disables this function.</p> <p>Note: This feature does not function if Set Login Mode is disabled. See <i>SET LOGIN MODE</i>, page 42.</p>
EDIT PORT NAMES	<p>To help remember which computer is attached to a particular port, every port can be given a name. This function allows the administrator to create, modify, or delete port names.</p> <p>To edit a port name:</p> <ol style="list-style-type: none"> Click the port, or use the navigation keys to move the highlight bar to it, then press [Enter]. Key in the new port name, or modify/delete the old one. The maximum number of characters allowed for the port name is 12. Legal characters include: <ul style="list-style-type: none"> ◆ All alpha characters: A–Z ◆ All numeric characters: 0–9 ◆ * () + : - , ? . / <p>Case does not matter; the OSD displays the port name in all capitals no matter how they were keyed in.</p> When you have finished editing, press [Enter] to have the change take effect. To abort the change, press [Esc].
RESTORE DEFAULT VALUES	<p>This function is used to undo all changes and return the setup to the original factory default settings (See <i>Factory Default Hotkeys and Settings</i>, page 74) except for the port name list, username and password information, which are saved.</p>
CLEAR THE NAME LIST	<p>This function clears the port name list.</p>
ACTIVATE BEEPER	<p>Choices are Y (on), or N (off). When activated, the beeper sounds whenever a port is changed; when activating the Auto Scan function (see <i>F7 SCAN</i>, page 44); or an invalid entry is made on an OSD menu. The default is Y.</p>

(Continues on next page.)

(Continued from previous page.)

Setting	Function
SET QUICK VIEW PORTS	<p>This function lets the administrator select which ports to include as quick view ports.</p> <ul style="list-style-type: none"> ◆ To select/deselect a port as a quick view port, double-click the port, or use the navigation keys to move the highlight bar to it, then press [Spacebar]. ◆ When a port has been selected as a quick view port, an icon displays in the QV column of the LIST on the main screen. When a port is deselected, the icon disappears. ◆ If one of the quick view options is chosen for the LIST view (see <i>F2 LIST</i>, page 36), only a port that has been selected here will display on the list. ◆ If one of the quick view options is chosen for auto-scanning (see <i>SCAN/SKIP MODE</i>, page 38), only a port that has been selected here will be auto-scanned. <p>The default has no ports selected for quick view.</p>
SET OPERATING SYSTEM	<p>This function allows the administrator to define the operating system for the computer connected to each KVM port. The default is WIN (PC compatible).</p> <p>To set the port operating system:</p> <ol style="list-style-type: none"> 1. From the list, select the port for which you wish to set the computer's operating system. 2. Set the operating system by pressing [Spacebar] to cycle through WIN, MAC, SUN, or OTHER . 3. Press [Esc] to exit. The operating system you selected is assigned to the KVM port.
FIRMWARE UPGRADE	<p>In order to upgrade the CS1768 / CS1788 firmware (see page 59), you must first enable Firmware Upgrade mode with this setting.</p> <p>When you bring up this menu, the current firmware version levels are displayed. Select Y to enable Firmware Upgrade mode, or N to leave this menu without enabling it.</p>
KEYBOARD LANGUAGE	<p>Sets the language for the computer keyboard attached to the KVM port. To select a keyboard language, double-click it, or use the navigation keys to move the highlight bar to it, then press [Enter].</p> <p>Choices are: AUTO (default), ENGLISH (US), ENGLISH (UK), GERMAN (GER.), GERMAN (SWISS), FRENCH, HUNGARIAN, ITALIAN, JAPANESE, KOREAN, RUSSIAN, SPANISH, SWEDISH, TRADITIONAL CHINESE, and SIMPLIFIED CHINESE.</p>

(Continues on next page.)

(Continued from previous page.)

Setting	Function
SET COMPUTER VIDEO INPUT	<p>Sets the video signal for each KVM port for the computers attached to the CS1768 / CS1788.</p> <p>Options are:</p> <ul style="list-style-type: none"> ◆ DVI-A ◆ DVI-D
SET CONSOLE VIDEO OUTPUT	<p>Sets the console video output. If the computer attached to the CS1768 / CS1788 is VGA output, this can be set to display on either the VGA or the DVI console monitor.</p> <p>Options are:</p> <ul style="list-style-type: none"> ◆ DVI-A to VGA – select this option if you have one DVI monitor with a DVI-D plus VGA connector, or if you have two monitors (1 x DVI, 1 x VGA) ◆ DVI-A to DVI-I – select this option if you have one DVI monitor with a DVI-I connector <p>Note: In a cascade installation or if you are using a VGA-to-DVI adapter in your installation, select DVI-A to DVI-I</p>
MOUSE EMULATION	<p>Enables / disable mouse emulation function.</p> <p>Note: Supported in the first level of an installation only.</p>
ACTIVATE Multi-view	<p>Enables multi-view mode for dual, triple or quad viewing in multiple-monitor installations where each computer is fitted with multiple video cards. See <i>Multi-view Installation</i>, page 24, for full details.</p> <p>Note: multi-view mode must be enabled on the OSD before the cables are connected.</p>
OSD CONFIG BACKUP / RESTORE	<p>Enters OSD Configuration Backup / Restore mode. The Firmware Management Utility lets you backup the current OSD configuration of the CS1768 / CS1788, and restore it when necessary. Storing the OSD configuration settings is useful when deploying more than one installation that uses the same settings. See <i>OSD Configuration Backup/Restore</i>, page 65, for full details.</p>
SET LOGIN MODE	<p>This function allows the administrator to request users to login or not. When the login dialog box is disabled, the system disables the login/logout function. If the system is re-started, the login/logout function remains disabled.</p>

F5: SKP

Clicking the **F5** field or pressing [**F5**] invokes Skip (SKP) mode. This function enables you to easily skip backward or forward – switching the console focus from the currently active computer port to the previous or next accessible one.

- ◆ The selection of computers available for skip mode switching is made with the *Scan-Skip* mode setting under the **F3: SET** function (see page 37).
- ◆ When you are in skip mode:
 - press [←] to skip to the previous accessible port on the list
 - press [→] to skip to the next accessible port on the list
 - press [↑] to skip to the next accessible port. If the next accessible port has cascaded a switch, then it skips to the first accessible port of that switch
 - press [↓] to skip to the previous accessible port. If the previous accessible port has cascaded a switch, then it skips to the last accessible port of that switch

Note: When you skip, you only skip to the previous or next accessible computer that is in the *Scan-Skip* mode selection (page 38).

- ◆ If a port has been selected for *Scan-Skip* mode, when the focus switches to that port a left/right triangle symbol appears before its port ID display. When the port ID with the triangle symbol displays, the background screen is blank.
- ◆ While skip mode is in effect, the console will not function normally. You must exit skip mode in order to regain control of the console.
- ◆ When the selected port displays, skip mode is automatically disabled.
- ◆ To exit skip mode, press [**Spacebar**] or [**Esc**].

F6: BRC

F6 is an administrator only function. Clicking the **F6** field, or pressing [**F6**], invokes *Broadcast* (BRC) mode. When this function is in effect, commands sent from the console are broadcast to all available computers on the installation.

This function is particularly useful for operations that need to be performed on multiple computers, such as performing a system wide shutdown, installing or upgrading software, etc.

- ◆ While BRC mode is in effect, a speaker symbol appears before the port ID display of the port that currently has the console focus. When the port ID with the speaker symbol displays, the background screen is blank.
- ◆ While BRC mode is in effect, the mouse will not function normally. You must exit BRC mode in order to regain control of the mouse.
- ◆ To exit BRC mode, invoke the OSD (with the OSD hotkey), then click the **F6** field, or press **[F6]**, to turn BRC mode off.
- ◆ When BRC mode is in effect, the Scroll Lock LED flashes. It stops flashing and reverts to normal status when you exit BRC.

F7: SCAN

Clicking the **F7** field or pressing **[F7]** invokes *Auto Scan* mode. This function allows you to automatically switch among the available computers at regular intervals so that you can monitor their activity without having to take the trouble of switching yourself.

- ◆ The selection of computers to be included for auto-scanning is made with the *Scan-Skip* mode setting under the **F3: SET** function (see page 38).
- ◆ The amount of time that each port displays for is set with the *Scan Duration* setting under the **F3: SET** function (see page 37). When you want to stop at a particular location, press the **[Spacebar]** to stop scanning.
- ◆ If the scanning stops on an empty port, or one where the computer is attached but is powered Off, the monitor screen will be blank, and the mouse and keyboard will have no effect. After the *Scan Duration* time is up, the scan function will move on to the next port.
- ◆ As each computer is accessed, an **S** appears in front of the port ID display to indicate that it is being accessed under *Auto Scan* mode. When the port ID with the symbol displays, the background screen is blank.
- ◆ While *Auto Scan* mode is in effect, the console will not function normally. You must exit *Auto Scan* mode in order to regain control of the console.
- ◆ While you are in *Auto Scan* mode, you can pause the scanning in order to keep the focus on a particular computer either by pressing **P**, or with a left-click of the mouse. See *Invoking Auto Scan*, page 49, for details.
- ◆ To exit *Auto Scan* mode, press the **[Spacebar]** or **[Esc]**.

F8: LOUT

Clicking the **F8** field, or pressing **[F8]** logs you out of OSD control of the computers, and blanks the console screen. This is different from simply pressing **[Esc]** when you are at the main screen to deactivate the OSD. With this function you must log in all over again to regain access to the OSD, whereas with **[Esc]**, all you have to do to reenter the OSD is tap the OSD hotkey.

-
- Note:**
1. When you reenter the OSD after logging out, the screen stays blank except for the OSD main screen. You must input your username and password before you can continue.
 2. If you reenter the OSD after logging out, and immediately use **[Esc]** to deactivate the OSD without having selected a port from the OSD menu, a null port message displays on the screen. The OSD hotkey will bring up the main OSD screen.
-

This Page Intentionally Left Blank

Chapter 5

Hotkey Operation

Hotkey Port Control

Hotkey port control allows you to provide KVM focus to a particular computer directly from the keyboard. The CS1768 / CS1788 provides the following hotkey port control features:

- ◆ Selecting the Active Port
- ◆ Auto Scan Mode Switching
- ◆ Skip Mode Switching
- ◆ Computer Keyboard / Mouse Reset
- ◆ Enable / Disable Mouse Emulation

The following settings can also be controlled in *Hotkey* mode:

- ◆ Setting the Beeper
- ◆ Setting the Quick Hotkey
- ◆ Setting the OSD Hotkey
- ◆ Setting the Port Operating System
- ◆ Restoring the OSD Default Values

Invoke Hotkey Mode

All hotkey operations begin by invoking *Hotkey* mode. There are two possible keystroke sequences used to invoke *Hotkey* mode, though only one can be operational at any given time:

Number Lock and Minus Keys

1. Hold down the **Num Lock** key;
2. Press and release the **minus** key;
3. Release the **Num Lock** key:

[Num Lock] + [-]

Control and F12 Keys

1. Hold down the **Ctrl** key;
2. Press and release the **F12** key;
3. Release the **Ctrl** key:

[Ctrl] + [F12]

When *Hotkey* mode is active:

- ♦ A command line appears on the monitor screen. The command line prompt is the word *Hotkey*: in white text on a blue background, and displays the subsequent hotkey information that you key in.
- ♦ Ordinary keyboard and mouse functions are suspended – only hotkey compliant keystrokes (described in the sections that follow), can be input.

Pressing [Esc] exits *Hotkey* mode.

Select the Active Port

Each KVM port is assigned a port ID (see *Port ID Numbering*, page 30). You can directly access any computer on the installation with a hotkey combination that specifies the port ID of the KVM port that a computer is connected to. To access a computer using hotkeys:

1. Invoke hotkey mode with the [Num Lock] + [-] or [Ctrl] + [F12] combination.

2. Key in the port ID.

The port ID numbers display on the command line as you key them in. If you make a mistake, use [Backspace] to erase the wrong number.

3. Press [Enter].

After you press [Enter], the KVM focus switches to the designated computer and you automatically exit hotkey mode.

Note: In hotkey mode, KVM focus will not switch to a port if an invalid switch or port number is entered. The hotkey command line will continue to display on the screen until you enter a valid switch and port number combination, or exit hotkey mode.

Auto Scan Mode

Auto Scan automatically switches, at regular intervals, among all the KVM ports that have been set as accessible under *Scan-Skip Mode*, so that their activity can be monitored automatically. See *Scan-Skip Mode* on page 38 for more information.

Invoking Auto Scan:

To start *Auto Scan*, key in the following Hotkey combination:

1. Invoke hotkey mode with the [**Num Lock**] + [-] or [**Ctrl**] + [**F12**] combination.
2. Press [**A**]. After you press **A**, then [**Enter**], you automatically exit hotkey mode, and enter *Auto Scan* mode.

- ◆ While you are in *Auto Scan* mode, you can pause the scanning in order to keep the focus on a particular computer either by pressing **P** or with a left click of the mouse. During the time that auto-scanning is paused, the command line displays: **Auto Scan: Paused**.

Pausing when you want to keep the focus on a particular computer is more convenient than exiting *Auto Scan* mode because when you resume scanning, you start from where you left off. If, on the other hand, you exited and restarted, scanning would start over from the very first computer on the installation.

To resume Auto Scanning, press any key or left-click. Scanning continues from where it left off.

- ◆ While *Auto Scan* mode is in effect, ordinary keyboard and mouse functions are suspended – only *Auto Scan* mode compliant keystrokes and mouse clicks can be input. You must exit *Auto Scan* mode in order to regain normal control of the console.
3. To exit *Auto Scan* mode press [**Esc**] or [**Spacebar**]. Auto-scanning stops when you exit *Auto Scan* mode.

Skip Mode

This feature allows you to switch between computers in order to monitor them manually. You can dwell on a particular port for as long as you like – as opposed to auto-scanning, which automatically switches after a fixed interval. To invoke *Skip* mode, key in the following hotkey combination:

1. Invoke hotkey mode with the [**Num Lock**] + [-] or [**Ctrl**] + [**F12**] combination.
2. Key in [**Arrow**]
 - ◆ Where [Arrow] refers to one of the arrow keys. After you press an arrow, you automatically exit hotkey mode and enter *Skip* mode where you can switch ports as follows:

←	Skips to the previous accessible port. (See <i>Scan/Skip Mode</i> , page 38, for information regarding accessible ports.)
→	Skips to the next accessible port.
↑	Skips to the next accessible port. If the next accessible port has cascaded a switch, then it skips to the first accessible port of that switch.
↓	Skips to the previous accessible port. If the previous accessible port has cascaded a switch, then it skips to the last accessible port of that switch.

- ◆ Once you are in *Skip* mode, you can keep on skipping by pressing the arrow keys. You don't have to use the [**Num Lock**] + [-] combination again.
 - ◆ While *Skip* mode is in effect, ordinary keyboard and mouse functions are suspended – only *Skip* mode compliant keystrokes can be input. You must exit *Skip* mode in order to regain normal control of the console.
3. To exit *Skip* mode, press [**Esc**] or [**Spacebar**].

Keyboard / Mouse Reset

If the keyboard or mouse cease to function on the computer connected to the currently selected port, you can perform a keyboard / mouse reset on the computer. This function is essentially the same as unplugging and replugging the keyboard and mouse on the target computer. To perform a computer keyboard / mouse reset, key in the following hotkey combination:

1. Invoke hotkey mode with the **[Num Lock] + [-]** or **[Ctrl] + [F12]** combination.
2. Press **[F5]**.

After you press [F5] you automatically exit *Hotkey* mode and regain keyboard and mouse control on the computer connected to the KVM port. If you fail to regain keyboard / mouse control on the computer after pressing [F5], perform a console keyboard and mouse reset. For more information see *Port LEDs*, page 7.

Hotkey Beeper Control

The beeper (see *Activate Beeper*, page 40) can be hotkey toggled on and off. To toggle the beeper, key in the following hotkey combination:

1. Invoke hotkey mode with the **[Num Lock] + [-]** or **[Ctrl] + [F12]** combination.
2. Press **[B]**.

After you press [B], the beeper toggles on or off. The command line displays *Beeper On* or *Beeper Off* for one second; then the message disappears and you automatically exit hotkey mode.

Quick Hotkey Control

The *Quick Hotkey* (see *HOTKEY*, page 38) can be toggled between [Num Lock] + [-], and [Ctrl] + [F12]. To toggle the *Quick Hotkey*:

1. Invoke hotkey mode with the [Num Lock] + [-] or [Ctrl] + [F12] combination.
2. Press [H].

After you press [H], the command line displays *HOTKEY HAS BEEN CHANGED* for one second; then the message disappears and you automatically exit *Hotkey* mode.

OSD Hotkey Control

The *OSD Hotkey* (see *OSD HOTKEY*, page 37) can be toggled between [Scroll Lock], [Scroll Lock] and [Ctrl], [Ctrl]. To toggle the *OSD Hotkey*, key in the following hotkey combination:

1. Invoke hotkey mode with the [Num Lock] + [-] or [Ctrl] + [F12] combination.
2. Press [T].

After you press [T], the command line displays *HOTKEY HAS BEEN CHANGED* for one second; then the message disappears and you automatically exit *Hotkey* mode.

Port OS Control

A port's operating system can be changed to match that of the computer attached to the port. To change a port's operating system, key in the following hotkey combination:

1. Invoke hotkey mode with the [**Num Lock**] + [-] or [**Ctrl**] + [**F12**] combination.
2. Key in [**Function**], where [Function] refers to one of the function keys in the following table:

Key	Description
F1	Sets the Port OS to Windows
F2	Sets the Port OS to Mac
F3	Sets the Port OS to Sun

After pressing a function key you automatically exit *Hotkey* mode.

Restore Default Values

This administrator only hotkey restores the CS1768 / CS1788 default values. See “Factory Default Hotkeys and Settings” on page 74. To restore the default values, key in the following hotkey combination:

1. Invoke hotkey mode with the [**Num Lock**] + [-] or [**Ctrl**] + [**F12**] combination.
2. Press [**R**].
3. Press [**Enter**].

After you press [Enter], the command line displays *RESET TO DEFAULT SETTING* for three seconds; then the message disappears and you automatically exit *Hotkey* mode.

USB Reset

If the USB loses focus and needs to be reset, do the following:

1. Invoke HSM (see page 47).
2. Press and release [**F5**].

Hotkey Buzzer Control

The Buzzer can be enabled or disabled. The default setting is enabled. To disable the Buzzer, do the following:

1. Invoke HSM (see page 47).
2. Press and release [**B**].

This procedure is a toggle. Repeat to enable.

Restore Default Settings

To reset the CS1768 / CS1788 to its default hotkey settings, do the following:

1. Invoke HSM (see page 47).
2. Press [**R**] [**Enter**].

See *Factory Default Hotkeys and Settings*, page 74

Video DynaSync

Video DynaSync is ATEN's exclusive technology that eliminates boot-up display problems and optimizes resolution when switching between ports. To invoke Video DynaSync, do the following:

1. Invoke HSM (see page 47)
2. Press [**D**].

Note: If the monitor is disconnected and reconnected, the CS1768 / CS1788 re-executes Video DynaSync.

Mouse Emulation Control

The default setting is enabled. To disable, do the following:

1. Invoke HSM (see page 47).
2. Press [**M**].

This procedure is a toggle. Repeat to enable.

HSM Summary Table

After invoking HSM (see page 47), key in one of the following keys to perform the corresponding function:

Key	Function
[PN] [Enter]	Switches KVM, Audio, and USB focus directly to the computer that corresponds to that port ID. (<i>PN</i> = port number)
[PN] [K] [Enter]	Switches KVM focus only directly to the computer that corresponds to that port ID. (<i>PN</i> = port number)
[PN] [U] [Enter]	Switches USB focus only directly to the computer that corresponds to that port ID. (<i>PN</i> = port number) Note: This hotkey functions on the first level of an installation only.
[A] [Enter]	Starts Auto Scan. The KVM focus cycles from port to port at the default 5-second intervals
[A] [<i>n</i>] [Enter]	Starts Auto Scan at <i>n</i> -second intervals (<i>n</i> = 1–255 seconds)
[H]	Toggles between the default ([Num Lock] [-]) and alternate ([Ctrl] [F12]) HSM invocation keys.
[T]	Toggles between the default ([Scroll Lock] [Scroll Lock]) and alternate ([Ctrl] [Ctrl]) Port Switching keys.
[F1]	Sets the port OS to Windows.
[F2]	Sets the port OS to Mac.
[F3]	Sets the port OS to Sun.
[F5]	Performs a keyboard / mouse reset on the target computer.
[B]	Enables/Disables the buzzer.
[R] [Enter]	Resets the hotkey settings to their default status. See <i>Factory Default Hotkeys and Settings</i> , page 74.
[D]	Invokes Video DynaSync, ATEN's exclusive technology that eliminates boot-up display problems and optimizes resolution when switching between ports.
[M]	Enables/Disables mouse emulation.
[←]	Skips to the previous computer on the list, in skip mode.









Key	Function
[→]	Skips to the next computer on the list, in skip mode.
[↑]	Skips to the next accessible port. If the next accessible port has cascaded a switch, then it skips to the first accessible port of that switch, in skip mode.
[↓]	Skips to the previous accessible port. If the previous accessible port has cascaded a switch, then it skips to the last accessible port of that switch, in skip mode.
[ESC] or [Spacebar]	Exits hotkey setting mode.

Chapter 6

Keyboard Emulation

Mac Keyboard







The PC compatible (101/104 key) keyboard can emulate the functions of the Mac keyboard. The emulation mappings are listed in the table below.

PC Keyboard	Mac Keyboard
[Shift]	Shift
[Ctrl]	Ctrl
	
[Ctrl] [1]	
[Ctrl] [2]	
[Ctrl] [3]	
[Ctrl] [4]	
[Alt]	Alt
[Print Screen]	F13
[Scroll Lock]	F14
	=
[Enter]	Return
[Backspace]	Delete
[Insert]	Help
[Ctrl] 	F15

Note: When using key combinations, press and release the first key (Ctrl), then press and release the activation key.

Sun Keyboard

The PC compatible (101/104 key) keyboard can emulate the functions of the Sun keyboard when the Control key [Ctrl] is used in conjunction with other keys. The corresponding functions are shown in the table below.

PC Keyboard	Sun Keyboard
[Ctrl] [T]	Stop
[Ctrl] [F2]	Again
[Ctrl] [F3]	Props
[Ctrl] [F4]	Undo
[Ctrl] [F5]	Front
[Ctrl] [F6]	Copy
[Ctrl] [F7]	Open
[Ctrl] [F8]	Paste
[Ctrl] [F9]	Find
[Ctrl] [F10]	Cut
[Ctrl] [1]	
[Ctrl] [2]	
[Ctrl] [3]	
[Ctrl] [4]	
[Ctrl] [H]	Help
	Compose
	

Note: When using key combinations, press and release the first key (Ctrl), then press and release the activation key.

Chapter 7

The Firmware Management Utility

Introduction

The purpose of the Windows-based Firmware Management Utility is to provide an automated process for upgrading all CS1768 / CS1788 switches in an installation. The program comes as part of a Firmware Upgrade Package that is specific for each device.

As new firmware versions become available, new firmware upgrade packages are posted on our website. Check the website regularly to find the latest information and packages.

Downloading the Firmware Upgrade Package

To download the firmware upgrade package:

1. From a computer that is not part of your KVM installation go to our website and choose the model name that relates to your device. A list of available firmware upgrade packages appears.
2. Choose the firmware upgrade package that you wish to install (usually the most recent) and download it to your computer.

Preparation

To prepare for the firmware upgrade, do the following:

1. Use the *Firmware Upgrade Cable* provided with this unit to connect a COM port on your computer to the *Firmware Upgrade Port* of your switch.

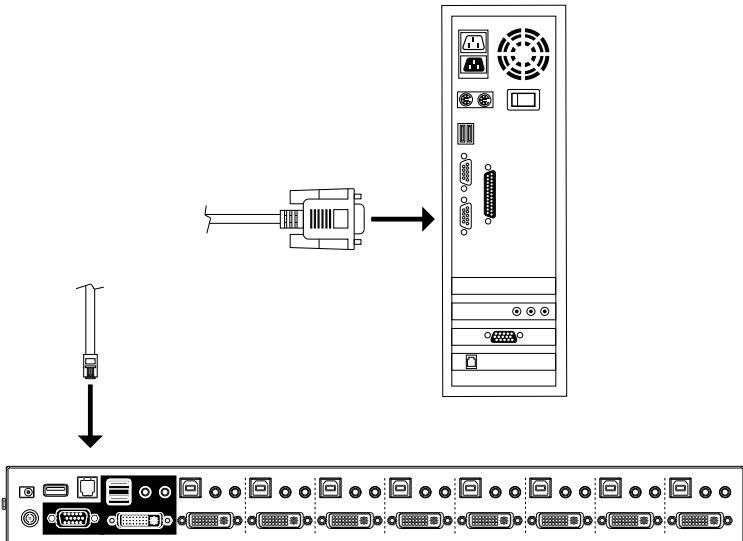

2. Shut down all the computers on the KVM installation.
3. From your KVM switch console, login to the OSD as the administrator (see p. 33) and select the **F4 ADM** function.
4. Scroll down to FIRMWARE UPGRADE. Press **[Enter]**, then press **[Y]** to invoke *Firmware Upgrade* mode (see p. 41.)

Starting the Upgrade

To upgrade the firmware:

1. Run the downloaded firmware upgrade package file either by double-clicking the file icon, or by opening a command line and entering the full path to it.

The *Firmware Upgrade Utility* welcome screen appears:

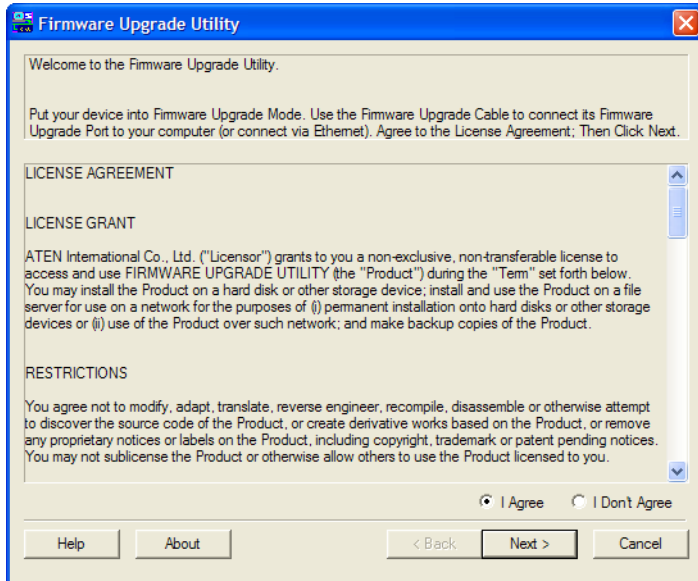

Note: The screens shown in this section are for reference only. The wording and layout of the actual screens put up by the *Firmware Upgrade Utility* may vary slightly from these examples.

2. Read and *Agree* to the License Agreement (enable the I Agree radio button).
3. Click **Next** to continue. The *Firmware Upgrade Utility* main screen appears. The devices capable of being upgraded are listed in the *Device List* panel:

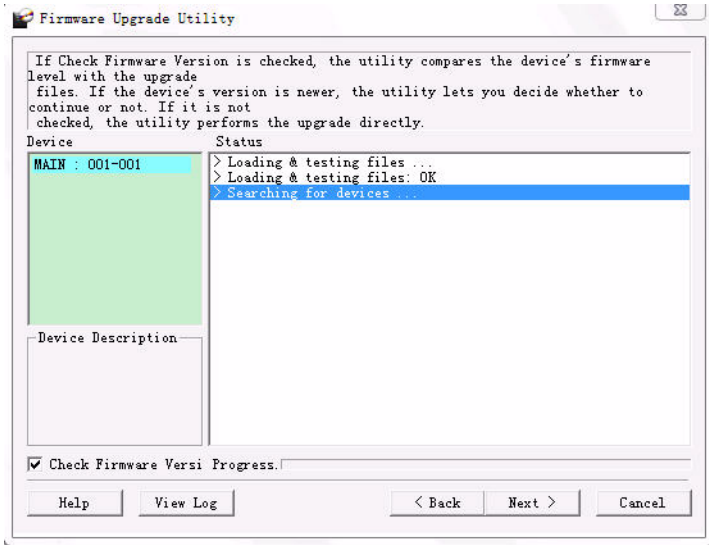

4. Click **Next** to perform the upgrade.

If you enabled *Check Firmware Version*, the Utility compares the device's firmware level with that of the upgrade files. If it finds that the device's version is higher than the upgrade version, it brings up a dialog box informing you of the situation and gives you the option to continue or cancel.

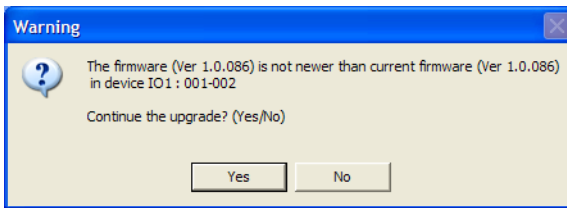

If you didn't enable *Check Firmware Version*, the Utility installs the upgrade files without checking whether they are a higher level, or not.

As the upgrade proceeds, status messages appear in the *Status Messages* panel, and the progress toward completion is shown on the *Progress* bar.

Upgrade Succeeded

After the upgrade has completed, a screen appears to inform you that the procedure was successful.

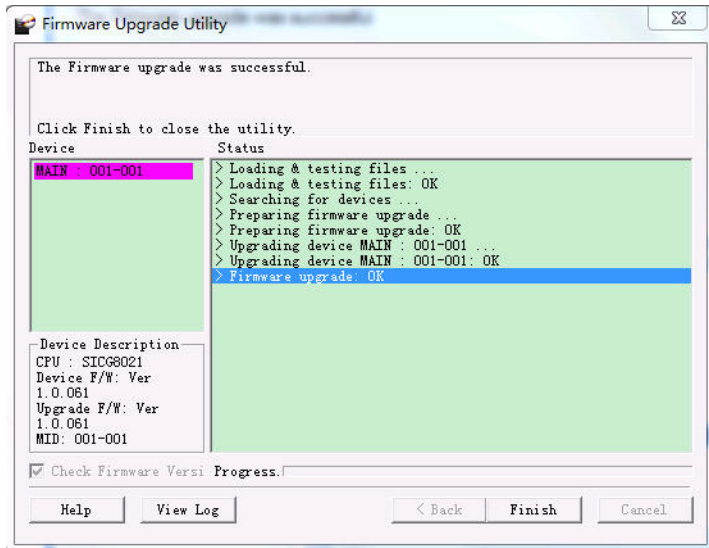

Click **Finish** to close the *Firmware Upgrade Utility*.

Upgrade Failed

If the *Upgrade Succeeded* screen doesn't appear, it means that the upgrade failed to complete successfully. See the next section, *Firmware Upgrade Recovery*, for how to proceed.

Firmware Upgrade Recovery

There are three conditions that call for firmware upgrade recovery:

- ◆ When a firmware upgrade is manually aborted.
- ◆ When the mainboard firmware upgrade fails.
- ◆ When the I/O firmware upgrade fails.

To perform a firmware upgrade recovery, do the following:

1. Power off the switch.
2. Connect the *Firmware Upgrade Cable* to its *Firmware Upgrade Port*.
3. Slide the *Firmware Upgrade Recovery Switch* to the **Recover** position.
4. Power the switch back on and repeat the upgrade procedure.
5. After the switch has been successfully upgraded, power it off, and slide the *Firmware Upgrade Recovery Switch* back to the **Normal** position.
6. If the switch is one of the cascaded switches, plug it back into the installation.
7. Power the switch back on.

OSD Configuration Backup/Restore

The Firmware Management Utility lets you backup the current OSD configuration of the CS1768 / CS1788, and restore it when necessary. Storing the OSD configuration settings is useful when deploying more than one installation that uses the same settings.

Backup

Follow these steps to store a backup file to a local computer:

1. Make sure your computer is connected to the CS1768 / CS1788. See *Preparation*, page 60, and follow steps 1–3.
2. When you have selected the **F4 ADM** function, scroll down to OSD CONFIG BACKUP / RESTORE. Press **[Enter]**, then press **[Y]** to invoke *OSD Config Backup / Restore* mode.
3. Run the Firmware Management Utility. In the dialog box, choose *OSD Configuration Backup/Restore*, then click Next.
4. In the window that appears, click *Connect Device*.

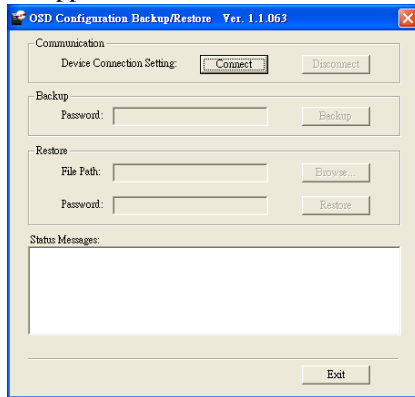

5. In the *Password* field, key in a password for the file.

Note: Setting a password is optional. If you do not set one, the file can be restored without specifying a password.

6. Click **Backup**.
7. When the browser asks what you want to do with the file, select *Save to disk*, then save it in a convenient location.

Restore

Follow these steps to restore a backup file from a local computer:

1. Do steps 1 to 3 of the previous section. See *Backup*, page 65.
2. Click **Restore** to recover an OSD configuration stored in the local computer. If you have previously set a password for this feature, enter the password in the provided field before clicking **Restore**. A confirmation window appears; click **Yes** to proceed.
3. Browse for the OSD configuration file you want to use and click **Restore**. Make sure the backup file is in the local computer.
4. A confirmation window appears when the restore process is done and successful. Click **OK** to close it.

Safety Instructions

General

- ◆ Read all of these instructions. Save them for future reference.
- ◆ Follow all warnings and instructions marked on the device.
- ◆ Do not place the device on any unstable surface (cart, stand, table, etc.). If the device falls, serious damage will result.
- ◆ Do not use the device near water.
- ◆ Do not place the device near, or over, radiators or heat registers.
- ◆ The device cabinet is provided with slots and openings to allow for adequate ventilation. To ensure reliable operation, and to protect against overheating, these openings must never be blocked or covered.
- ◆ The device should never be placed on a soft surface (bed, sofa, rug, etc.) as this will block its ventilation openings. Likewise, the device should not be placed in a built in enclosure unless adequate ventilation has been provided.
- ◆ Never spill liquid of any kind on the device.
- ◆ Unplug the device from the wall outlet before cleaning. Do not use liquid or aerosol cleaners. Use a damp cloth for cleaning.
- ◆ The device should be operated from the type of power source indicated on the marking label. If you are not sure of the type of power available, consult your dealer or local power company.
- ◆ The device is designed for IT power distribution systems with 230V phase-to-phase voltage.
- ◆ To prevent damage to your installation it is important that all devices are properly grounded.
- ◆ The device is equipped with a 3-wire grounding type plug. This is a safety feature. If you are unable to insert the plug into the outlet, contact your electrician to replace your obsolete outlet. Do not attempt to defeat the purpose of the grounding-type plug. Always follow your local/national wiring codes.
- ◆ Do not allow anything to rest on the power cord or cables. Route the power cord and cables so that they cannot be stepped on or tripped over.

- ◆ If an extension cord is used with this device make sure that the total of the ampere ratings of all products used on this cord does not exceed the extension cord ampere rating. Make sure that the total of all products plugged into the wall outlet does not exceed 15 amperes.
- ◆ To help protect your system from sudden, transient increases and decreases in electrical power, use a surge suppressor, line conditioner, or un-interruptible power supply (UPS).
- ◆ Position system cables and power cables carefully; Be sure that nothing rests on any cables.
- ◆ Never push objects of any kind into or through cabinet slots. They may touch dangerous voltage points or short out parts resulting in a risk of fire or electrical shock.
- ◆ Do not attempt to service the device yourself. Refer all servicing to qualified service personnel.
- ◆ If the following conditions occur, unplug the device from the wall outlet and bring it to qualified service personnel for repair.
 - ◆ The power cord or plug has become damaged or frayed.
 - ◆ Liquid has been spilled into the device.
 - ◆ The device has been exposed to rain or water.
 - ◆ The device has been dropped, or the cabinet has been damaged.
 - ◆ The device exhibits a distinct change in performance, indicating a need for service.
 - ◆ The device does not operate normally when the operating instructions are followed.
- ◆ Only adjust those controls that are covered in the operating instructions. Improper adjustment of other controls may result in damage that will require extensive work by a qualified technician to repair.
- ◆ Do not connect the RJ-11 connector marked “UPGRADE” to a public telecommunication network.

Rack Mounting

- ◆ Before working on the rack, make sure that the stabilizers are secured to the rack, extended to the floor, and that the full weight of the rack rests on the floor. Install front and side stabilizers on a single rack or front stabilizers for joined multiple racks before working on the rack.
- ◆ Always load the rack from the bottom up, and load the heaviest item in the rack first.
- ◆ Make sure that the rack is level and stable before extending a device from the rack.
- ◆ Use caution when pressing the device rail release latches and sliding a device into or out of a rack; the slide rails can pinch your fingers.
- ◆ After a device is inserted into the rack, carefully extend the rail into a locking position, and then slide the device into the rack.
- ◆ Do not overload the AC supply branch circuit that provides power to the rack. The total rack load should not exceed 80 percent of the branch circuit rating.
- ◆ Make sure that all equipment used on the rack – including power strips and other electrical connectors – is properly grounded.
- ◆ Ensure that proper airflow is provided to devices in the rack.
- ◆ Ensure that the operating ambient temperature of the rack environment does not exceed the maximum ambient temperature specified for the equipment by the manufacturer.
- ◆ Do not step on or stand on any device when servicing other devices in a rack.
- ◆ **Caution:** Slide/rail (LCD KVM) mounted equipment is not to be used as a shelf or a work space.



Technical Support

International

- ◆ For online technical support – including troubleshooting, documentation, and software updates: **<http://support.aten.com>**
- ◆ For telephone support, see *Telephone Support*, page iii:

North America

Email Support		support@aten-usa.com
Online Technical Support	Troubleshooting Documentation Software Updates	http://www.aten-usa.com/support
Telephone Support		1-888-999-ATEN ext 4988

When you contact us, please have the following information ready beforehand:

- ◆ Product model number, serial number, and date of purchase.
- ◆ Your computer configuration, including operating system, revision level, expansion cards, and software.
- ◆ Any error messages displayed at the time the error occurred.
- ◆ The sequence of operations that led up to the error.
- ◆ Any other information you feel may be of help.

CS1768 / CS1788 Connection Tables

The following tables indicate the relationship between the number of units and the number of computers that they control:

MVs	Computers	MVs	Computers	MVs	Computers	MVs	Computers
1	1 - 8	20	134 - 141	39	267 - 274	58	400 - 407
2	8 - 15	21	141 - 148	40	274 - 281	59	407 - 414
3	15 - 22	22	148 - 155	41	281 - 288	60	414 - 421
4	22 - 29	23	155 - 162	42	288 - 295	61	421 - 428
5	29 - 36	24	162 - 169	43	295 - 302	62	428 - 435
6	36 - 43	25	169 - 176	44	302 - 309	63	435 - 442
7	43 - 50	26	176 - 183	45	309 - 316	64	442 - 449
8	50 - 57	27	183 - 190	46	316 - 323	65	449 - 456
9	57 - 64	28	190 - 197	47	323 - 330	66	456 - 463
10	64 - 71	29	197 - 204	48	330 - 337	67	463 - 470
11	71 - 78	30	204 - 211	49	337 - 344	68	470 - 477
12	78 - 85	31	211 - 218	50	344 - 351	69	477 - 484
13	85 - 92	32	218 - 225	51	351 - 358	70	484 - 491
14	92 - 99	33	225 - 232	52	358 - 365	71	491 - 498
15	99 - 106	34	232 - 239	53	365 - 372	72	498 - 505
16	106 - 113	35	239 - 246	54	372 - 379	73	505 - 512
17	113 - 120	36	246 - 253	55	379 - 386		
18	120 - 127	37	253 - 260	56	386 - 393		
19	127 - 134	38	260 - 267	57	393 - 400		

Specifications

Function		CS1768	CS1788	
Computer Connections	Direct	8		
	Max.	512 (via Cascade)		
Port Selection		OSD, Hotkey, Pushbutton		
Connectors	Console Ports	KB	1 x USB Type A Female (Black)	
		Video	1 x HDB-15 Female (Blue) / 1 x DVI-I Female (white)	
		Mouse	1 x USB Type A F (Black)	
		Speakers	2 x Mini Stereo Jack F (Green; 1 x front panel, 1 x rear panel)	
		Mic.	2 x Mini Stereo Jack F (Pink; 1 x front panel; 1 x rear panel)	
	KVM Ports	KB / Mouse	8 x USB Type B Female (White)	
		Video	8 x DVI-I Female (White)	
		Speakers	8 x Mini Stereo Jack Female (Green)	
		Mic.	8 x Mini Stereo Jack Female (Pink)	
	F/W Upgrade		1 x RJ11 Female (Black)	
	Power		1 x DC Jack	
	USB 2.0 Hub		2 x USB Type A Female (White; 1 x front panel, 1 x rear panel)	
	Switches	Port Selection	8 x Pushbutton	
		Reset	1 x Semi-recessed Pushbutton	
F/W Upgrade		1 x Slide Switch		
LEDs	USB Link	8 (Green)		
	on Line / Selected	8 (Orange)		
	Power	1 (Dark Green)		
Emulation	Keyboard / Mouse	USB		
Video	Digital	DVI Single Link: 1920 x 1200	DVI Dual Link: 2560 x 1600	
	Analog	2048 x 1536 (VGA); DDC2B		
Scan Interval		1–255 Seconds (Default: 5 secs)		
Power Consumption		DC 5.3 V; 6.36 W		
Environment	Operating Temp.	0–50°C		
	Storage Temp	-20–60°C		
	Humidity	0–80% RH, Non-condensing		
Physical Properties	Housing	Metal		
	Weight	2.80 kg		
	Dimensions (L x W x H)	43.72 x 16.11 x 4.40 cm		

Administrator Login Failure

If you are unable to perform an Administrator login (because the username/password information has become corrupted, or you have forgotten it, for example), you can clear the login information with the following procedure:

1. Power off the CS1768 / CS1788 and remove its housing.
2. Short the jumper labeled J30.

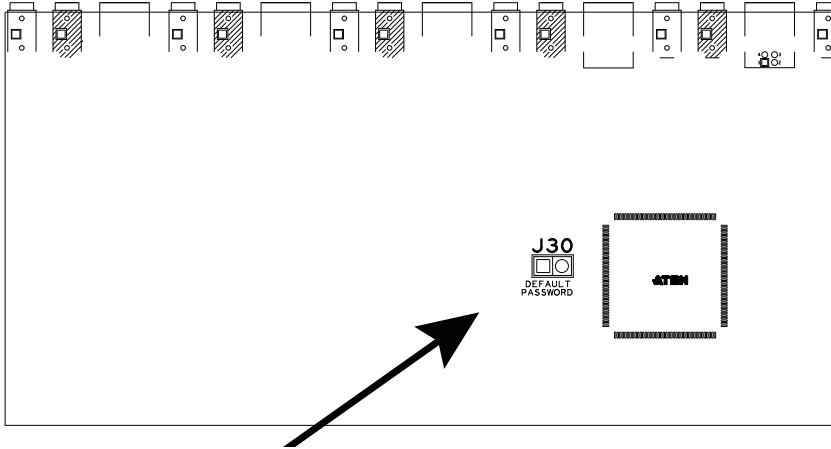

3. Power on the switch.
4. When the front panel LEDs flash, power off the switch.
5. Remove the jumper cap from J30.
6. Close the housing and start the CS1768 / CS1788 back up.

After you start back up, you can use the default login procedure (see *OSD Login*, page 33) to login.

Factory Default Hotkeys and Settings

Setting	Hotkey	Default
Port Switching (Default / Alternate)	[T]	[Scroll Lock] [Scroll Lock]
Invoking HSM	[H]	[Number Lock] [-]
Auto Scan Interval	[A] [Enter]	5 seconds
Mouse Emulation	[M]	Enabled
Port Switching Keys (On / Off)	[X] [Enter]	Enabled
Buzzer	[B]	Enabled
Video DynaSync	[D]	Enabled

Limited Warranty

IN NO EVENT SHALL THE DIRECT VENDOR'S LIABILITY EXCEED THE PRICE PAID FOR THE PRODUCT FROM DIRECT, INDIRECT, SPECIAL, INCIDENTAL, OR CONSEQUENTIAL DAMAGES RESULTING FROM THE USE OF THE PRODUCT, DISK, OR ITS DOCUMENTATION.

The direct vendor makes no warranty or representation, expressed, implied, or statutory with respect to the contents or use of this documentation, and especially disclaims its quality, performance, merchantability, or fitness for any particular purpose.

The direct vendor also reserves the right to revise or update the device or documentation without obligation to notify any individual or entity of such revisions, or update. For further inquiries, please contact your direct vendor.